

catálogo de sistema

QS-XL

SERIE PLEGABLE RPT



QUALITY  
SYSTEMS  
LINE

Quality Windows

**INDICE**  
INDEX

**QS-XL**

- **FICHA TÉCNICA.....3**  
DATA SHEET
- **ESQUEMA APERTURA.....4**  
OPENING SCHEME
- **LISTADO DE PERFILES.....5**  
LIST OF PROFILES
- **PERFILES ESCALA 1:1.....7**  
SCALE PROFILES 1:1
- **NUDOS ESCALA 1:1.....13**  
SCALE KNOTS 1:1
- **ACCESORIOS.....42**  
ACCESSORIES
- **HERRAJES.....43**  
HARDWARE
- **JUNTAS.....47**  
JOINTS
- **UTILLAJES.....49**  
TOOLING
- **SECCIONES.....50**  
SECTIONS
- **ACRISTALAMIENTO.....59**  
GLAZING
- **FORMULAS DE CORTE....75**  
CUTTING FORMULAS

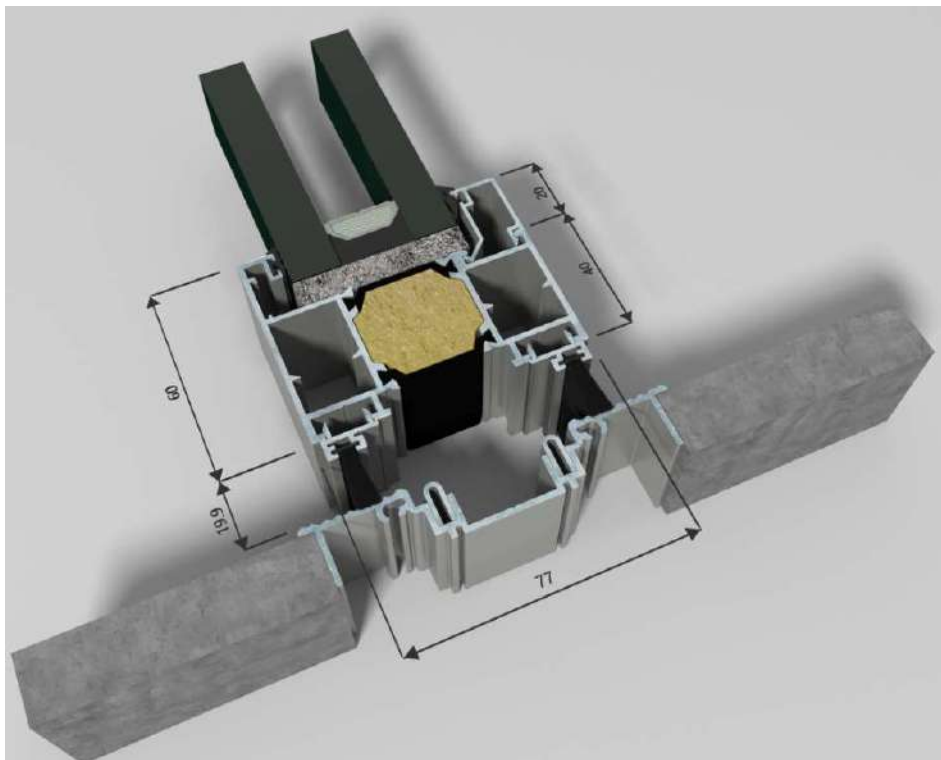

FICHA TÉCNICA

DATA SHEET

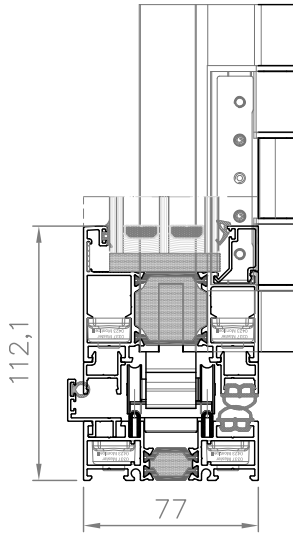

Isoterma  
Isotherm

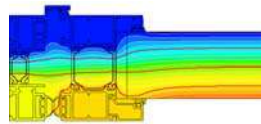

SECCIÓN HORIZONTAL  
HORIZONTAL SECTION

Cálculo de transmitancia ( $U_w$ ) para una puerta de 6 hojas, de dimensiones 5.400 x 2.500 mm  
Calculation of transmittance ( $U_w$ ) for a door of 6 sashes with, dimensions 5.400 x 2.500 mm

Eficiencia térmica Thermal efficiency	INTERCALARIO VIDRIO Glass interlayer	$\psi_g$ [W/mK]	Vidrio doble Double glass					Vidrio triple Triple glass			
			$U_g$ [W/m <sup>2</sup> K]					$\psi_g$ [W/mK]	$U_g$ [W/m <sup>2</sup> K]		
			2.0	1.6	1.3	1.1	0.9		0.9	0.7	0.5
	Perfil de ALUMINIO Aluminium profile	0.110	2.4	2.2	2.0	1.8	1.7	0.080	1.7	1.6	1.4
	SPACER M by Technoform	0.049	2.3	2.0	1.8	1.7	1.5	0.044	1.5	1.4	1.2
	SPACER PRECISION by Technoform	0.036	2.2	1.9	1.7	1.6	1.5	0.031	1.5	1.3	1.2

Transmitancia Térmica:  $U_w$  desde 1,0 W/m<sup>2</sup>K Thermal Transmittance:  $U_w$  from 1,0 W/m<sup>2</sup>K

Secciones: marco 77 mm, hoja 77 mm. Longitud de Poliamida 32 mm. Polyamide length 32 mm.  
Sections: frame 77 mm, sash 77 mm. Poliamida 6.6 con 25% de fibra de vidrio Polyamide 6.6 with 25% fiberglass

Acristalamiento: de 26 a 56 mm. Glazing: from 26 to 56 mm.

Clasificación: Classification:

Permeabilidad al aire

Air permeability

UNE-EN 12207:2000

Estanteidad al agua

Watertightness

UNE-EN 12208:2000

Resistencia al viento

Wind resistance

UNE-EN 12210:2017

CLASE 1	CLASE 2	CLASE 3	CLASE 4						
1A	2A	3A	4A	5A	6A	7A	8A	9A	E1500
C1	C2	C3	C4	C2/A3					

Ensayo de referencia sobre balconera de una hoja paralela-deslizante con fijo lateral, de 2.700 x 2.300 mm.

Reference test on a balcony door with a parallel fully-opening leaf with lateral fixed, 2.700 x 2.300 mm.

Aislamiento acústico: Desde  $\leq 38$  dB Soundproofing: From  $\leq 38$  dB

Dimensiones máximas de hoja: Ancho (L) = 1.200 mm y alto (H) = 3.500 mm  
Maximum sash dimensions: Width (L) = 1.200 mm and height (H) = 3.500 mm

Peso máximo por hoja: Hasta 120 kg con herraje exclusivo de QS-XL  
Maximum weight per sash: Up to 120 kg with exclusive QS-XL hardware

Posibilidades de apertura: Opening possibilities:  
2 hojas (220), 3 hojas (330, 321), 4 hojas (440, 431, 422), 2 sashes (220), 3 sashes (330, 321), 4 sashes (440, 431, 422),  
5 hojas (550, 541, 532), 6 hojas (660, 651, 642, 633), 5 sashes (550, 541, 532), 6 sashes (660, 651, 642, 633),  
7 hojas (770, 761, 752, 743), 8 hojas (880, 871, 862, 853, 844). 7 sashes (770, 761, 752, 743), 8 sashes (880, 871, 862, 853, 844).

## ESQUEMAS DE APERTURAS

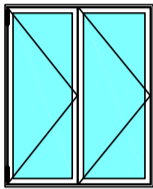

Esquema 220

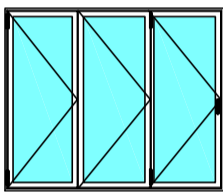

Esquema 330

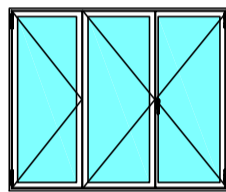

Esquema 321

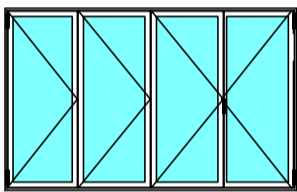

Esquema 431

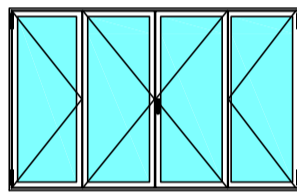

Esquema 422 - 440

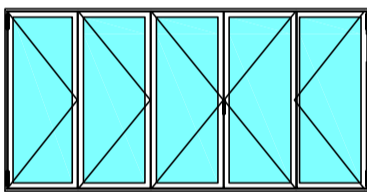

Esquema 532 - 541

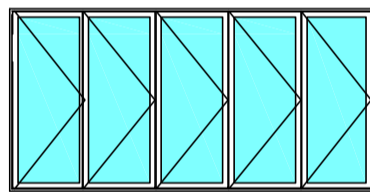

Esquema 550

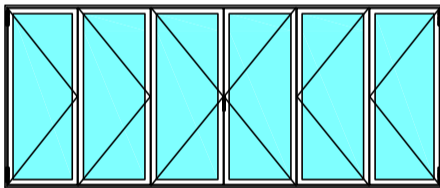

Esquema 633

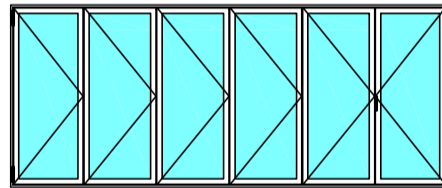

Esquema 651

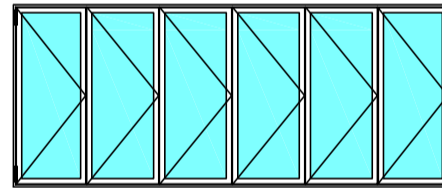

Esquema 660 - 642

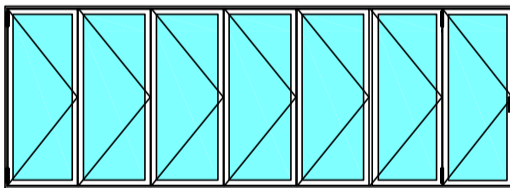

Esquema 770 - 752

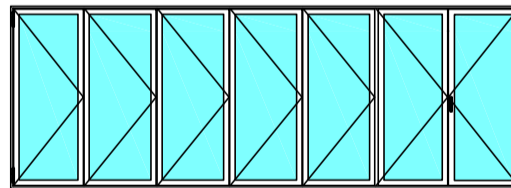

Esquema 761

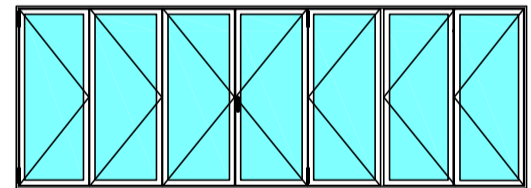

Esquema 743

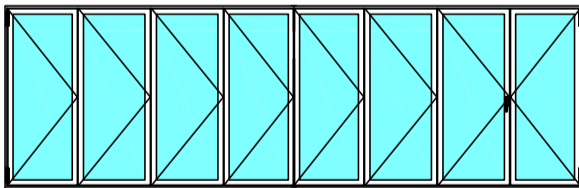



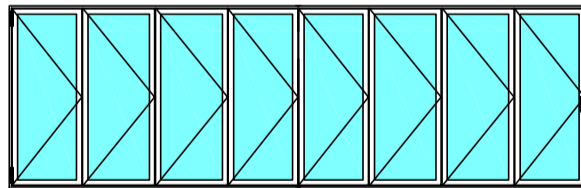















Esquema 871 - 853























Esquema 880

## LISTADO DE PERFILES | LIST OF PROFILES

Perfiles   Frames					
Sección   Section	Descripción   Description	Referencia   Cod.			
	Marco 77 mm <i>Frame 77 mm</i>	79100			
	Hoja 77 mm <i>Sash 77 mm</i>	79101			
	Complemento cerradura 77 mm <i>77 mm lock complement profile</i>	79102			
	Batiente <i>Profile support</i>	79103			
	Suplemento 14 mm <i>Supplement profile 14 mm</i>	79104			
	Complemento para felpudo <i>Profile Complement for felt</i>	79105			
	Solera enrasada 100 mm <i>Flush profile 100 mm</i>	79106		Anodizado Plata <i>Silver Anodized</i>	
	(*) Tapa 42 mm solera enrasada <i>Cover profile 42 mm flush profile</i>	*79107		Anodizado Plata <i>Silver Anodized</i>	
	(*) Marco con batiente 77 mm <i>Frame with 77 mm profile support</i>	*79108			
	(*) Compensador con batiente 77 mm <i>Compensator with support 77 mm</i>	*79109			
	(*) Vértice 90° - 90 <i>Vertex profile 90° - 90</i>	*79110			
	(*) Unión de marcos 77 mm <i>Frame union 77 mm</i>	*79111			
	(*) Unión de marcos oculto <i>Concealed frame union</i>	*79112			
	Travesaño 70 x 71 mm <i>Divider profile 70 x 71 mm</i>	77002			
	Travesaño 70 x 83 mm <i>Divider profile 70 x 83 mm</i>	77012			
	Travesaño 70 x 97 mm <i>Divider profile 70 x 97 mm</i>	77022			
	Travesaño 70 x 130 mm <i>Divider profile 70 x 130 mm</i>	77032			
	Travesaño 70 x 130 mm <i>Divider profile 70 x 130 mm</i>	77042			
	Ángulo 20 x 20 mm <i>Angle 20 x 20 mm</i>	942020			

LISTADO DE PERFILES | LIST OF PROFILES

Perfiles   Frames					
Sección   Section	Descripción   Description	Referencia   Cod.			
	Junquillo recto 7 mm (hueco = 59,5 mm) <i>Straight glazing bar 7 mm (H=59,5 mm)</i>	447907			
	Junquillo recto 10 mm (hueco = 56,2 mm) <i>Straight glazing bar 10 mm (H=56,2 mm)</i>	447910			
	Junquillo recto 13,8 mm (hueco = 52,7 mm) <i>Straight glazing bar 13,8 mm (H=52,7 mm)</i>	447914			
	Junquillo recto 17,3 mm (hueco = 49,2 mm) <i>Straight glazing bar 17,3 mm (H=49,2 mm)</i>	447917			
	Junquillo recto 20,8 mm (hueco = 45,7 mm) <i>Straight glazing bar 20,8 mm (H=45,7 mm)</i>	447921			
	Junquillo recto 24,3 mm (hueco = 42,2 mm) <i>Straight glazing bar 24,3 mm (H=42,2 mm)</i>	447924			
	Junquillo recto 27,3 mm (hueco = 39,2 mm) <i>Straight glazing bar 27,3 mm (H=39,2 mm)</i>	447927			
	Junquillo recto 31,3 mm (hueco = 35,2 mm) <i>Straight glazing bar 31,3 mm (H=35,2 mm)</i>	447930			
	Junquillo recto 34,8 mm (hueco = 31,7 mm) <i>Straight glazing bar 34,8 mm (H=31,7 mm)</i>	447935			
	Junquillo curvo 14 mm (hueco = 52,5 mm) <i>Curved glazing bar 14 mm (H=52,5 mm)</i>	447714			
	Junquillo curvo de grapa 14 mm (hueco = 52,5 mm) <i>Curved staple glazing bar 14 mm (H=52,5 mm)</i>	447814			
	Junquillo curvo 24,5 mm (hueco = 42 mm) <i>Curved glazing bar 24,5 mm (H=42 mm)</i>	447724			
	Junquillo curvo de grapa 24,5 mm (hueco = 42 mm) <i>Curved staple glazing bar 24,5 mm (H=42 mm)</i>	447824			
	Tapajunta recto con escalón 30 mm <i>Straight joint cover with step 30 mm</i>	19384			
	Tapajunta recto con escalón 35 mm <i>Straight joint cover with step 35 mm</i>	10307			
	Tapajunta curvo con escalón 40 mm <i>Curved joint cover with step 40 mm</i>	19385			
	Tapajunta recto con escalón 65 mm <i>Straight joint cover with step 65 mm</i>	10302			
	(*) Vierteaguas 60 mm <i>Edgings 60 mm</i>	10131			
	(*) Vierteaguas 80 mm <i>Edgings 80 mm</i>	10133			
	(*) Vierteaguas 170 mm <i>Edgings 170 mm</i>	10134			

**MARCOS**  
*FRAMES*

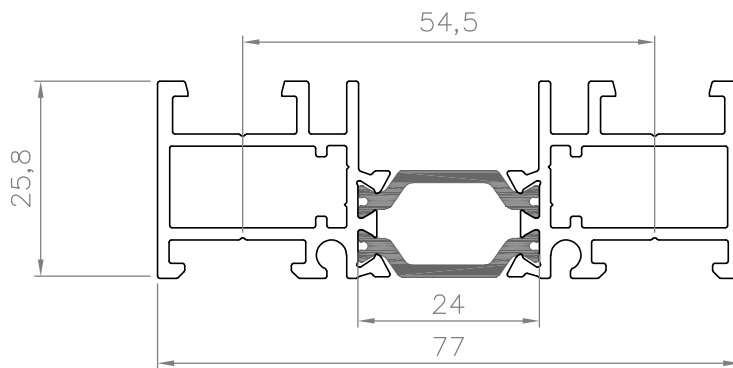

**79100**

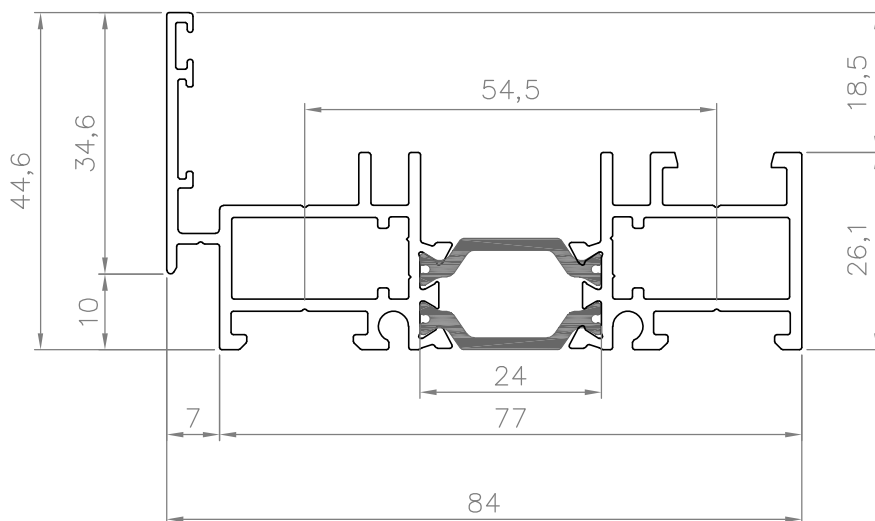

**\*79108**



**MARCOS**  
*FRAMES*

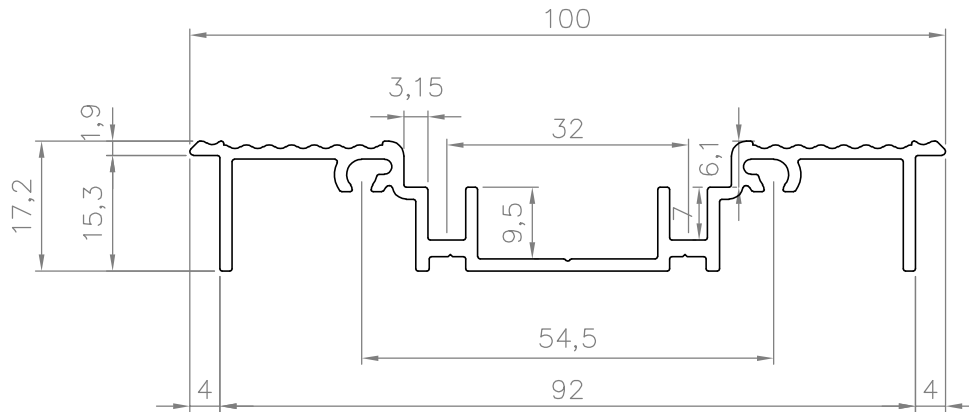

**79106**

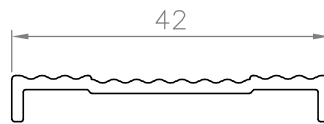

**\*79107**

**COMPENSADOR DE MARCO**  
*FRAME COMPENSATOR*

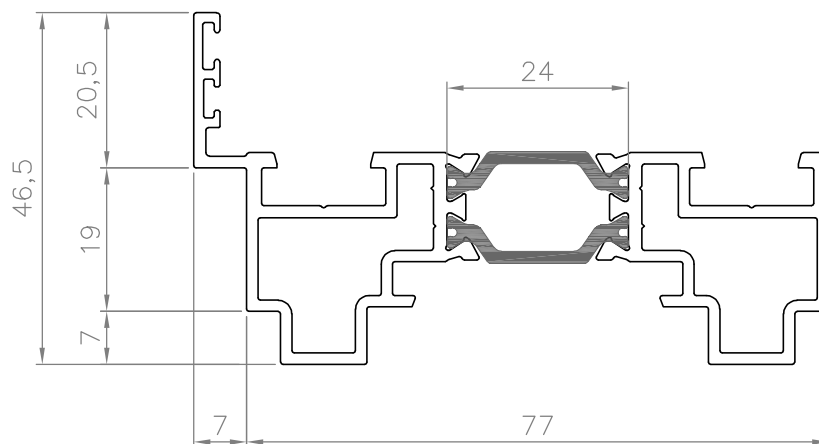

**\*79109**

**HOJA**  
*SASH*

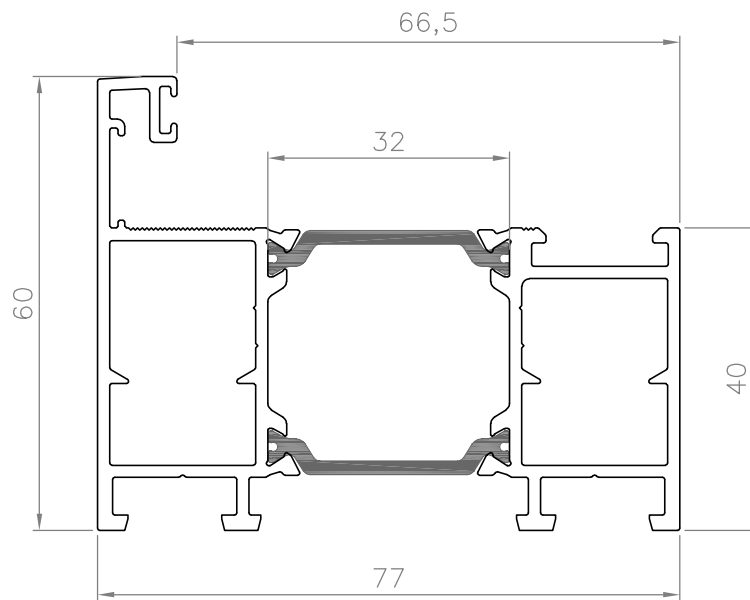

**79101**

**COMPLEMENTO CERRADURA**  
*LOCK COMPLEMENT PROFILE*

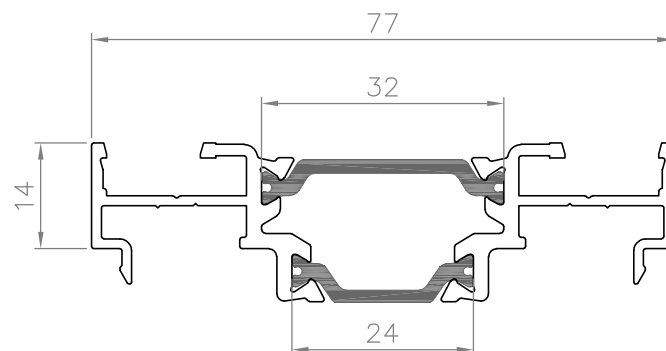

**79102**

**COMPLEMENTOS**  
*COMPLEMENTS*

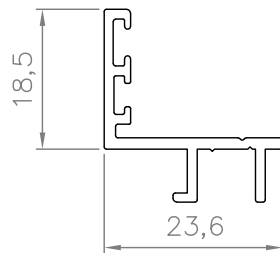

**79103**

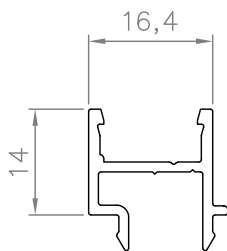

**79104**

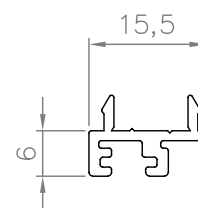

**79105**

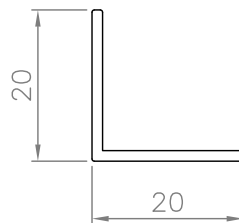

**942020**

## UNIONES DE MARCOS *FRAME UNIONS*

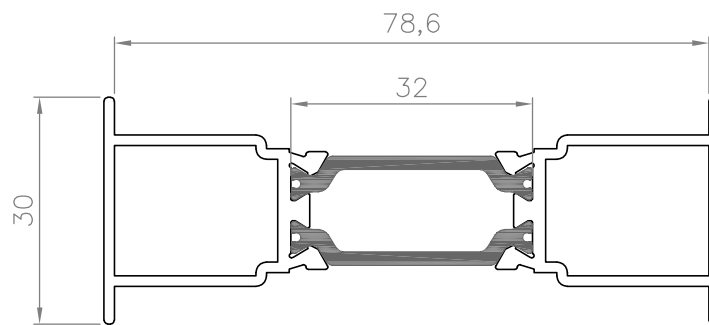

**\*79111**

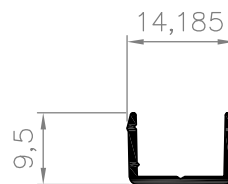

**\*79112**

# VÉRTICE 90° - 90°

VERTEX PROFILE 90° - 90°

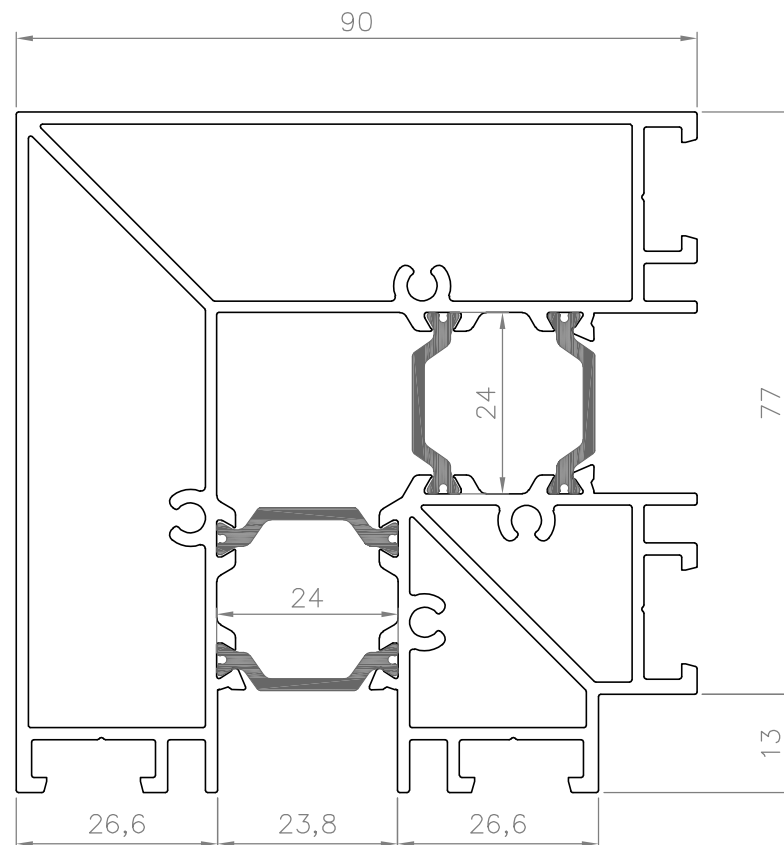

**\*79110**

Sección inferior  
*Lower section*

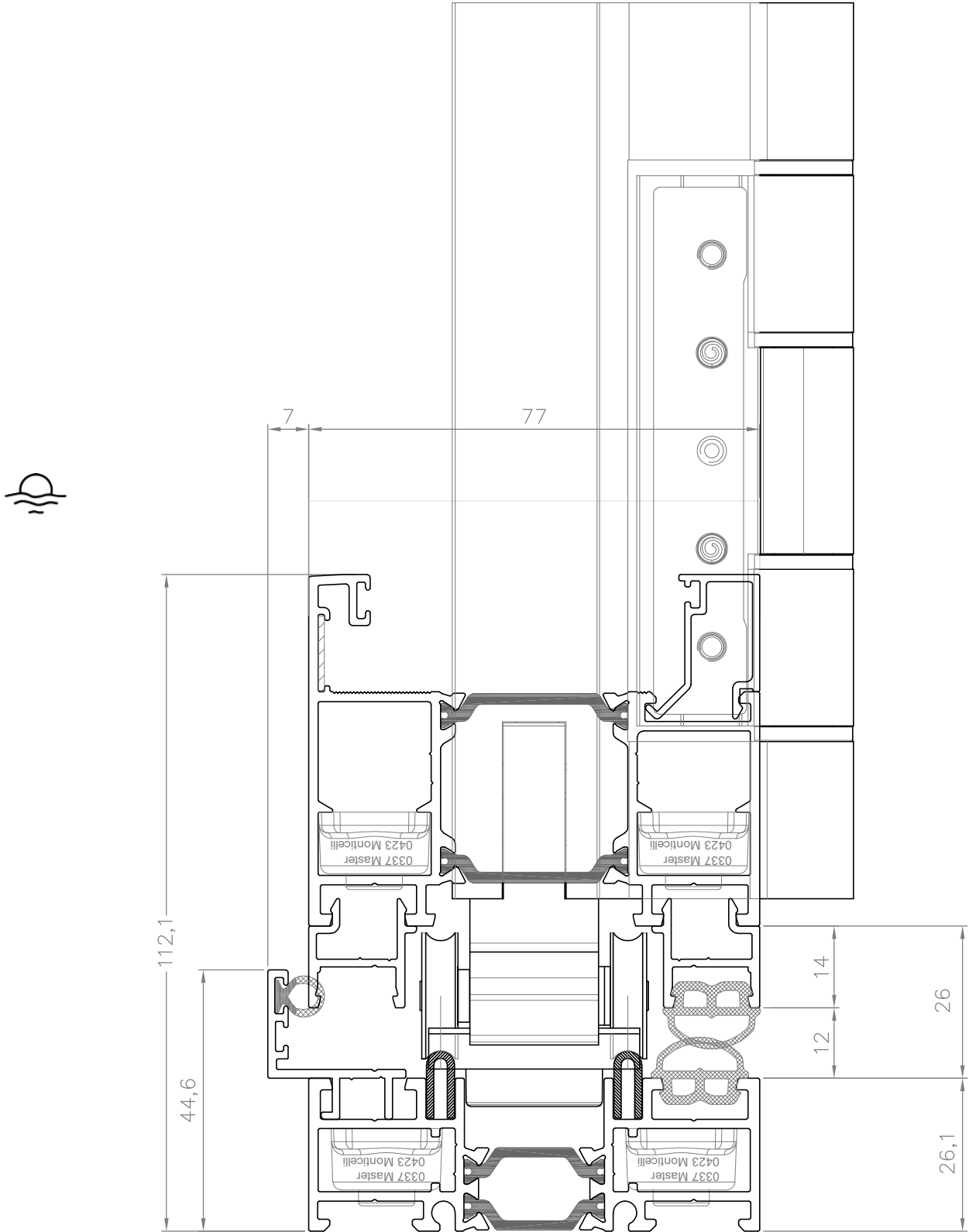

Sección inferior  
*Lower section*

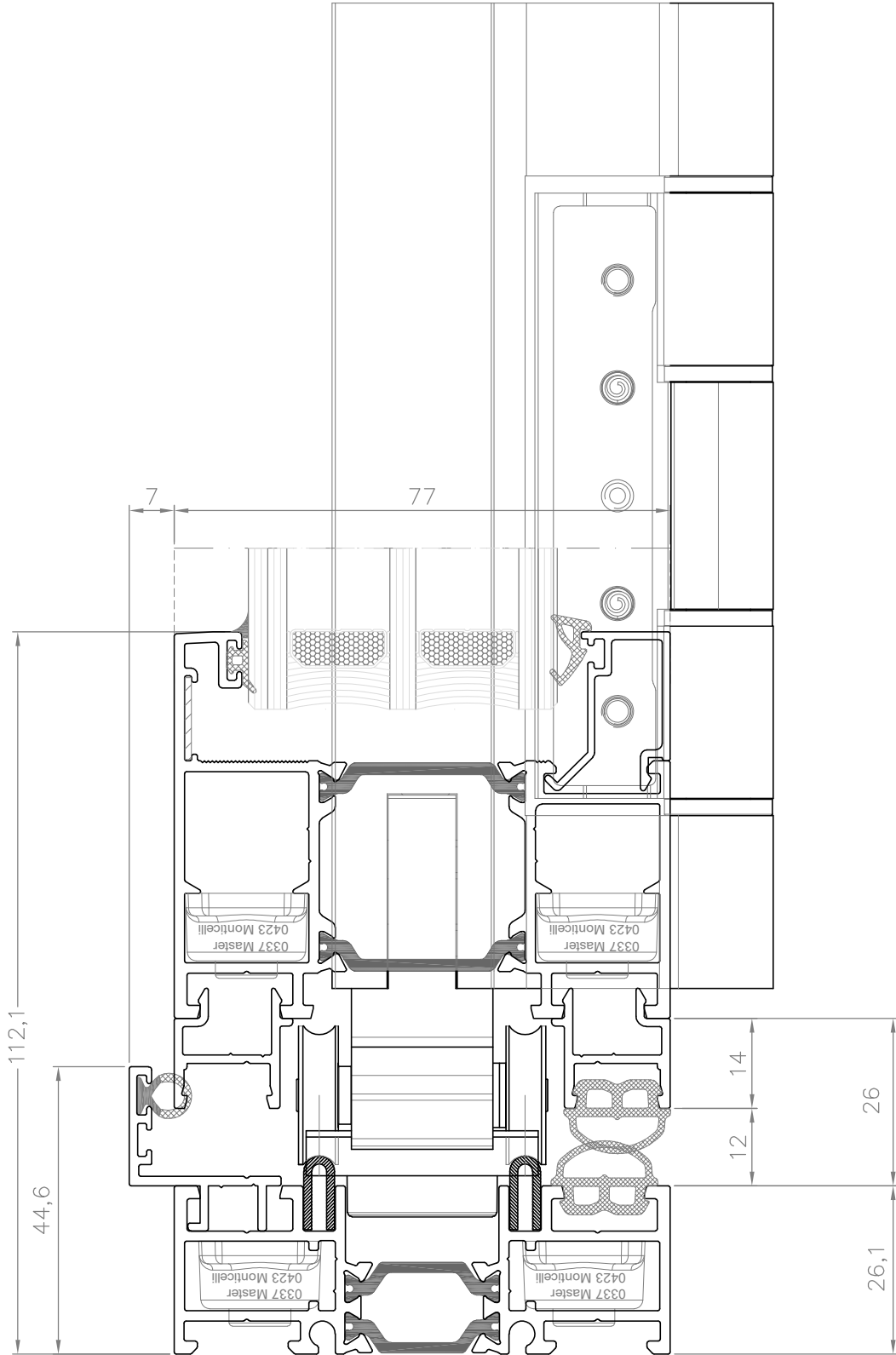
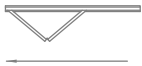
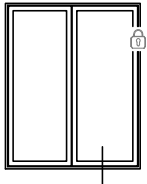

Sección inferior  
Lower section

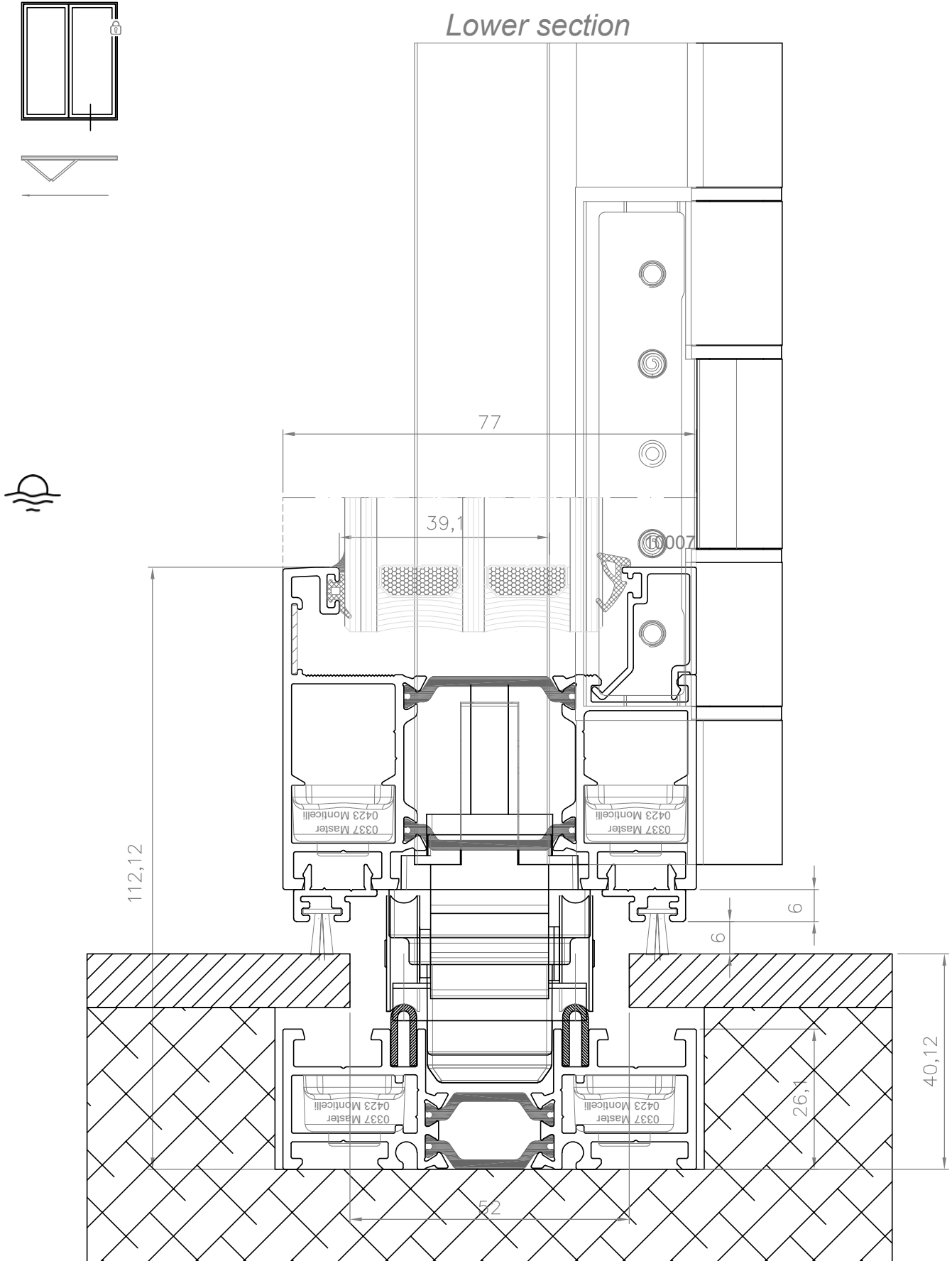



Sección inferior  
Lower section

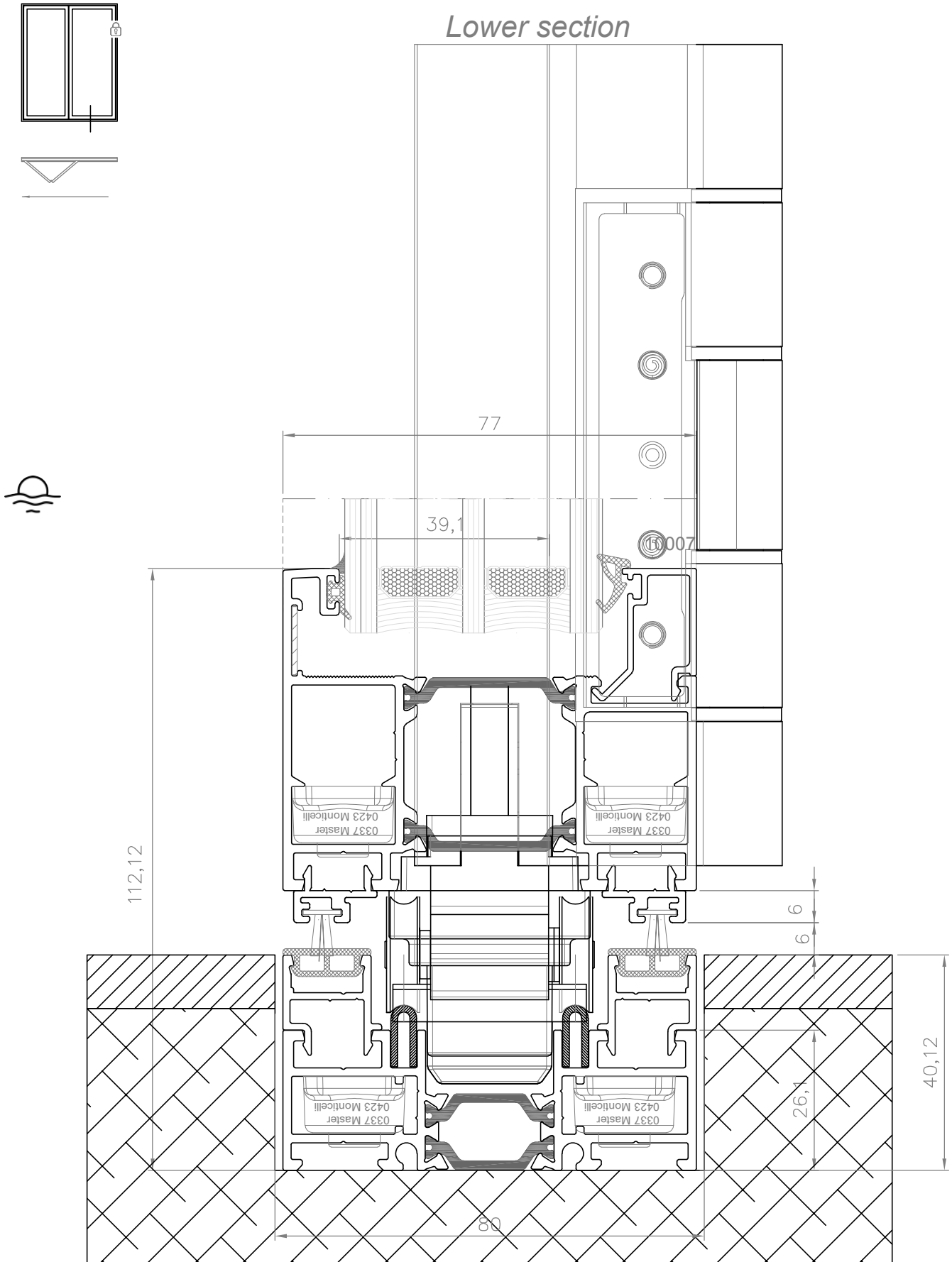

**Sección inferior**  
*Lower section*

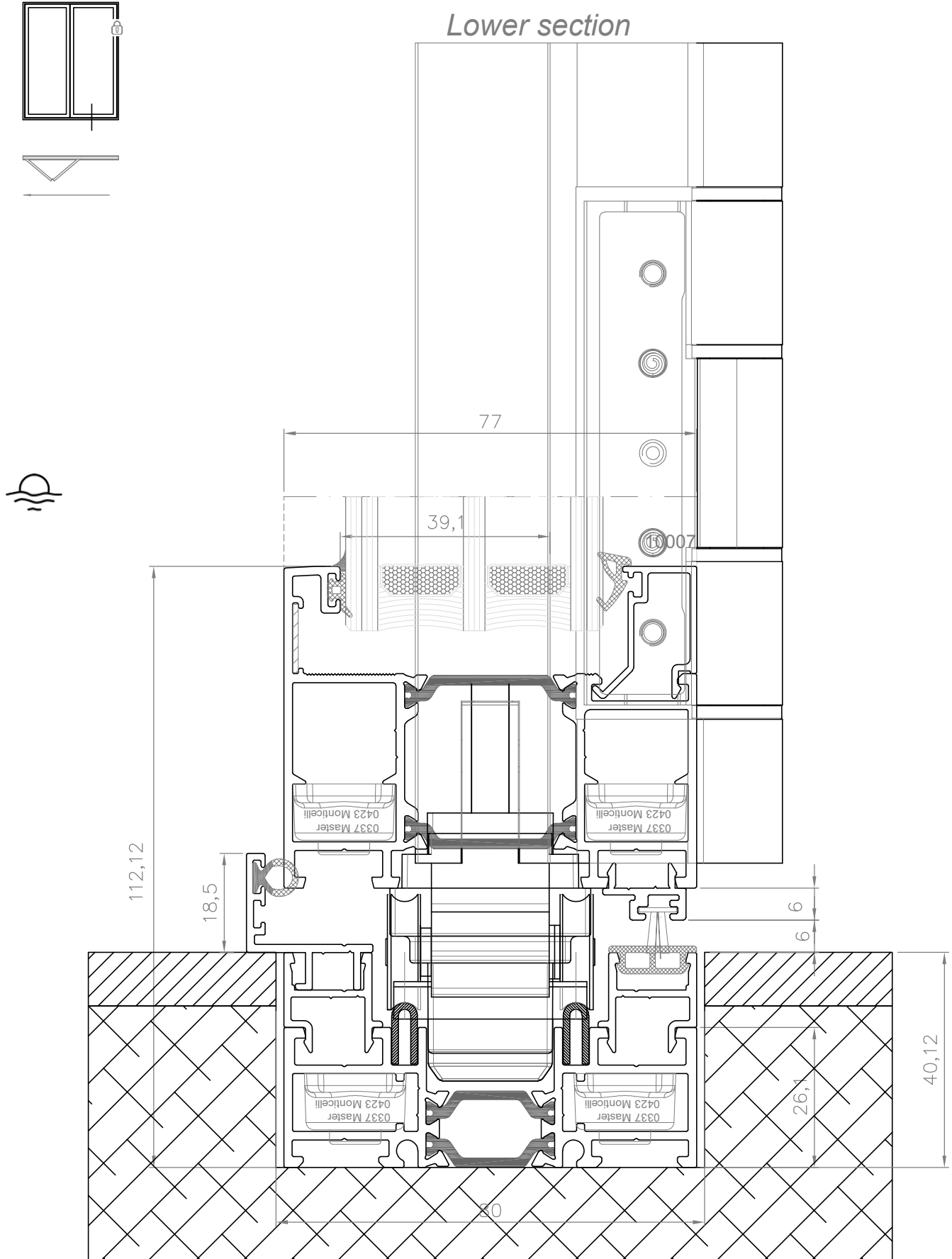

Sección inferior  
Lower section

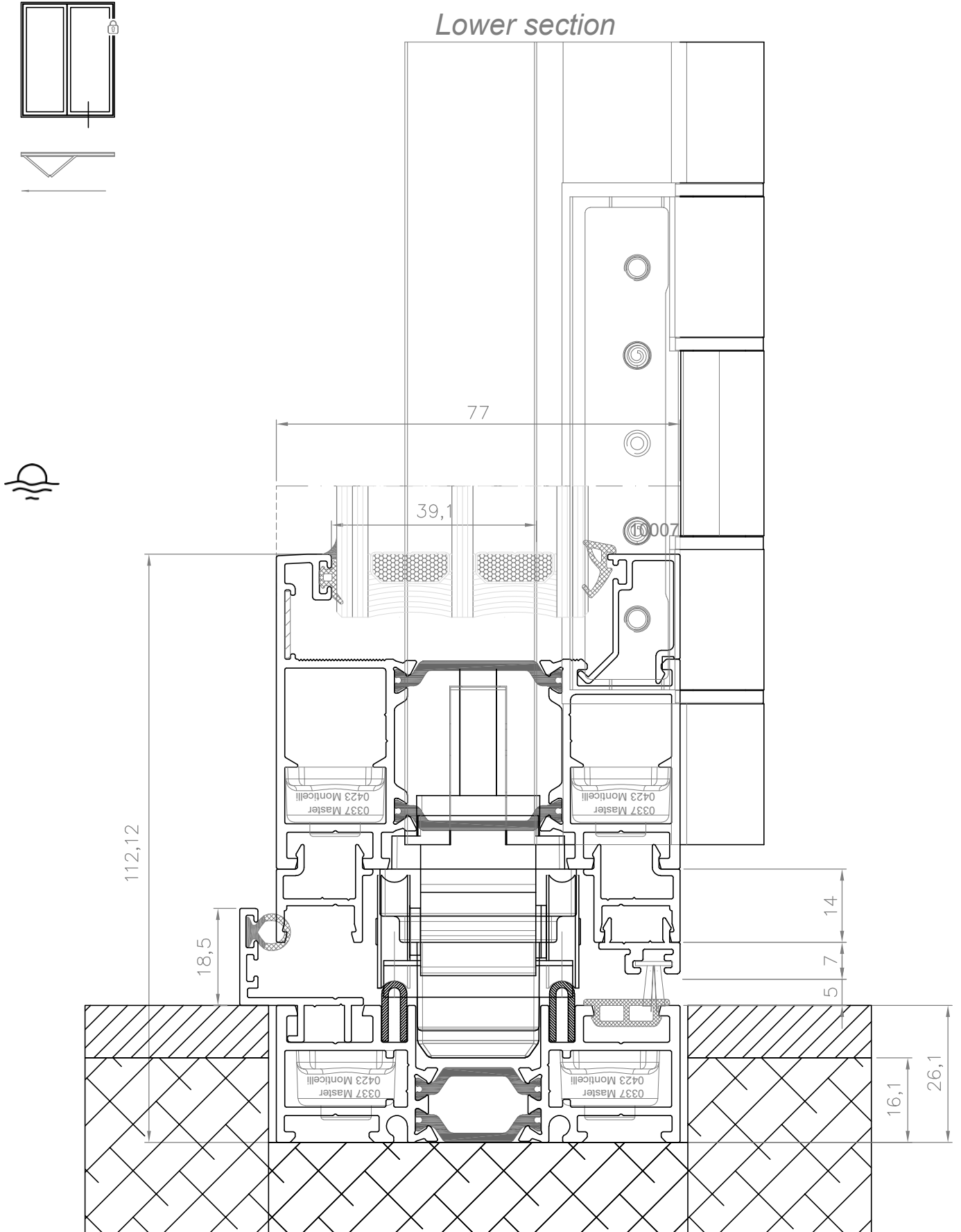

Sección inferior  
Lower section

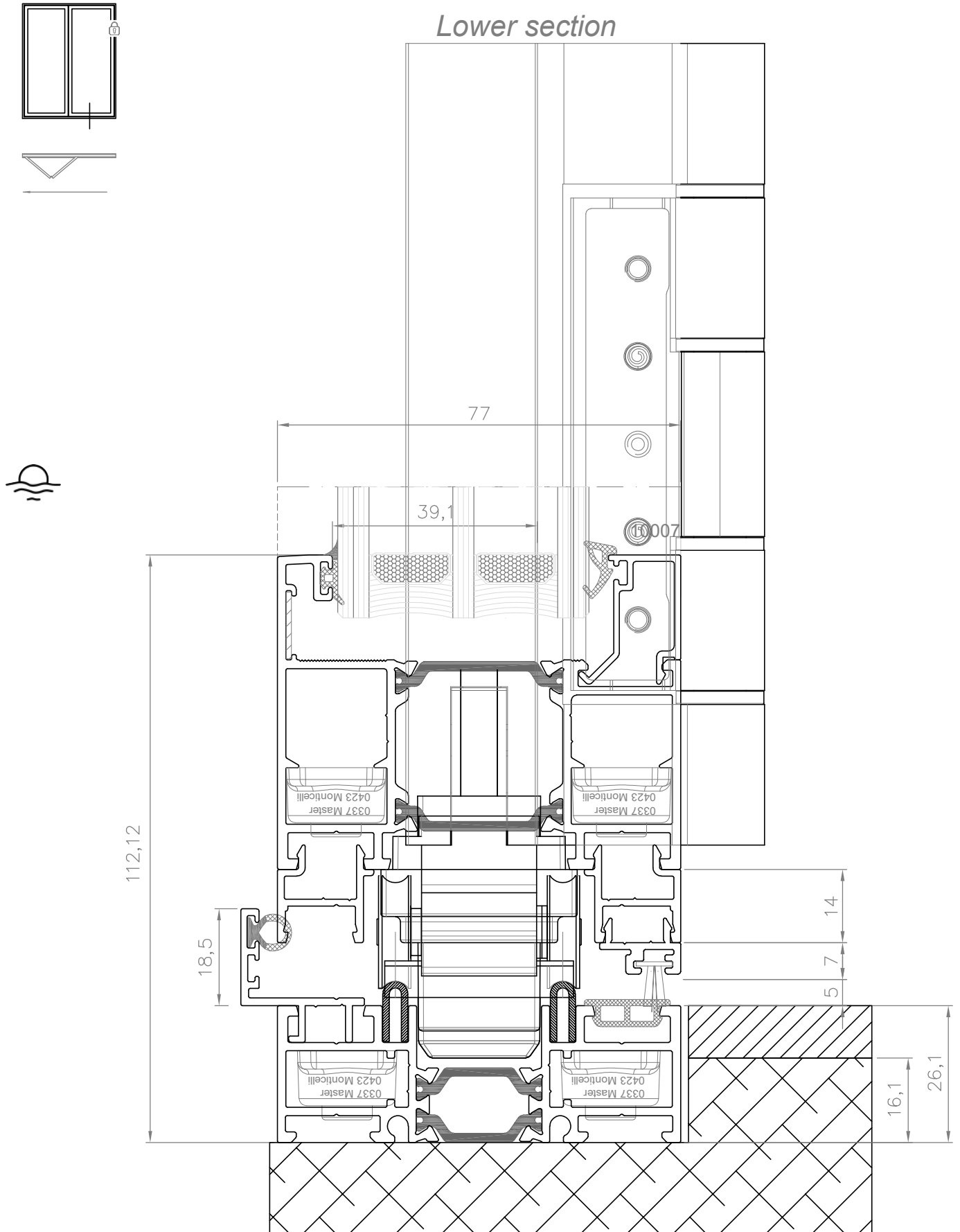

Sección inferior  
Lower section

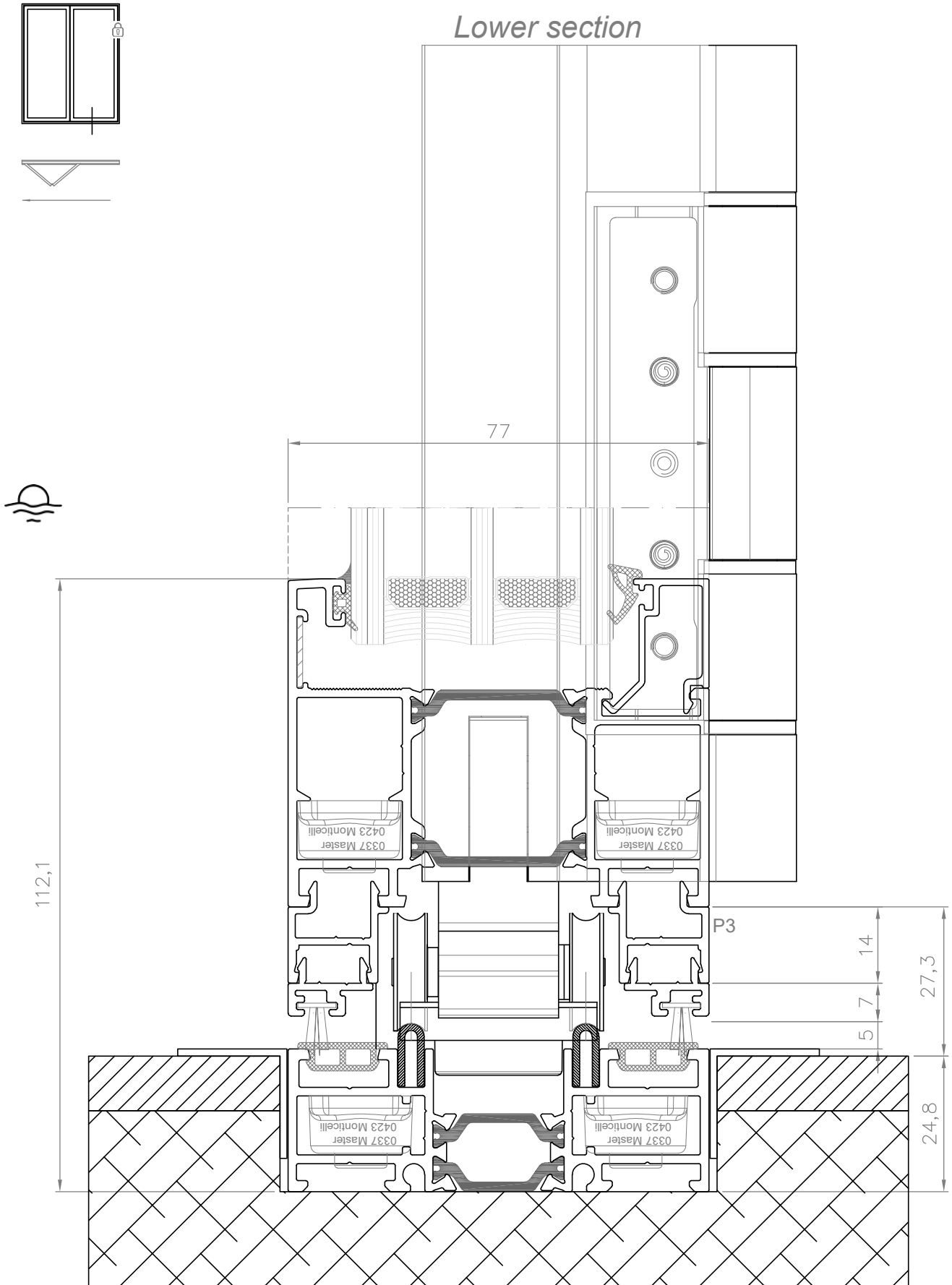

Sección inferior  
Lower section

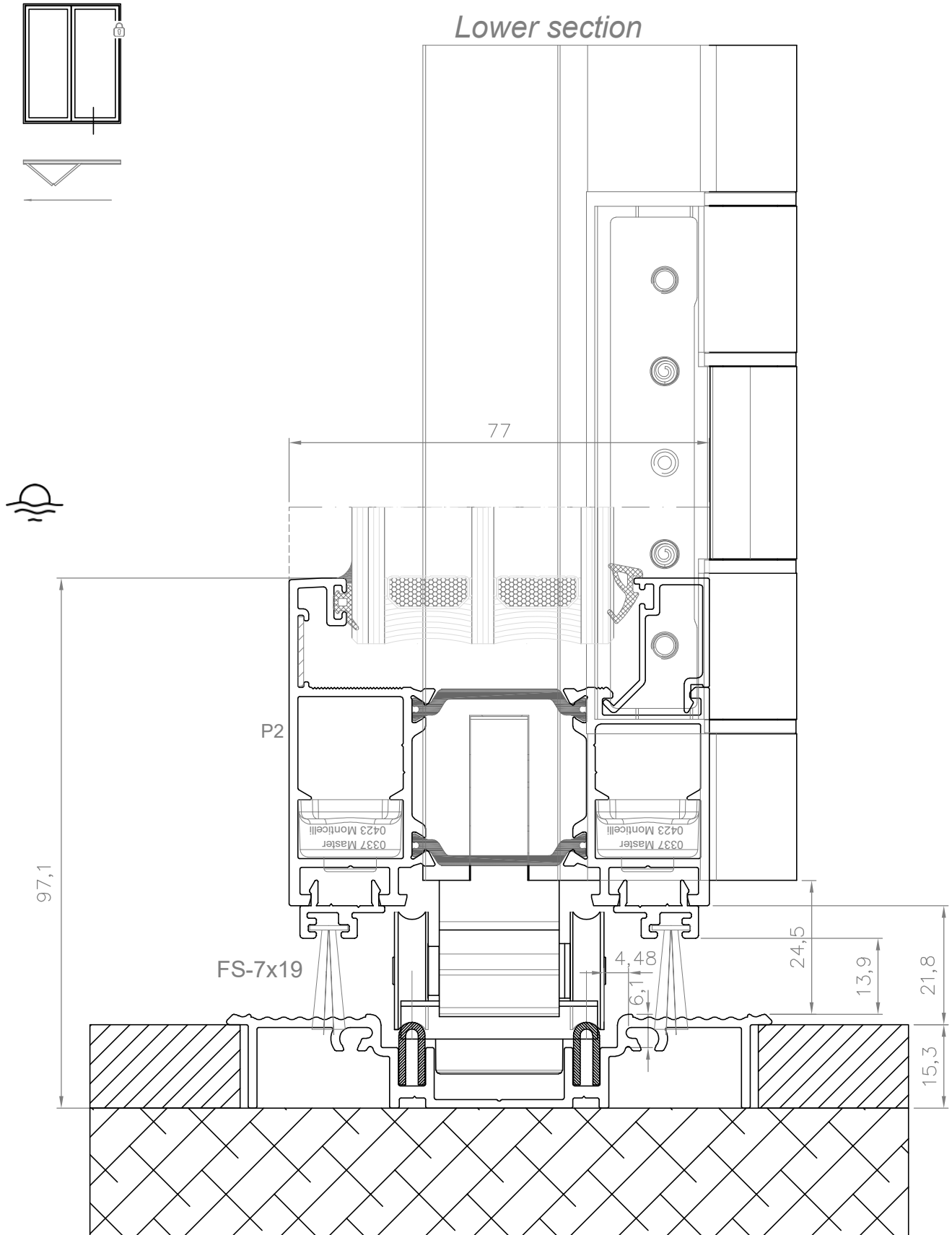

**Sección superior**  
*Upper section*

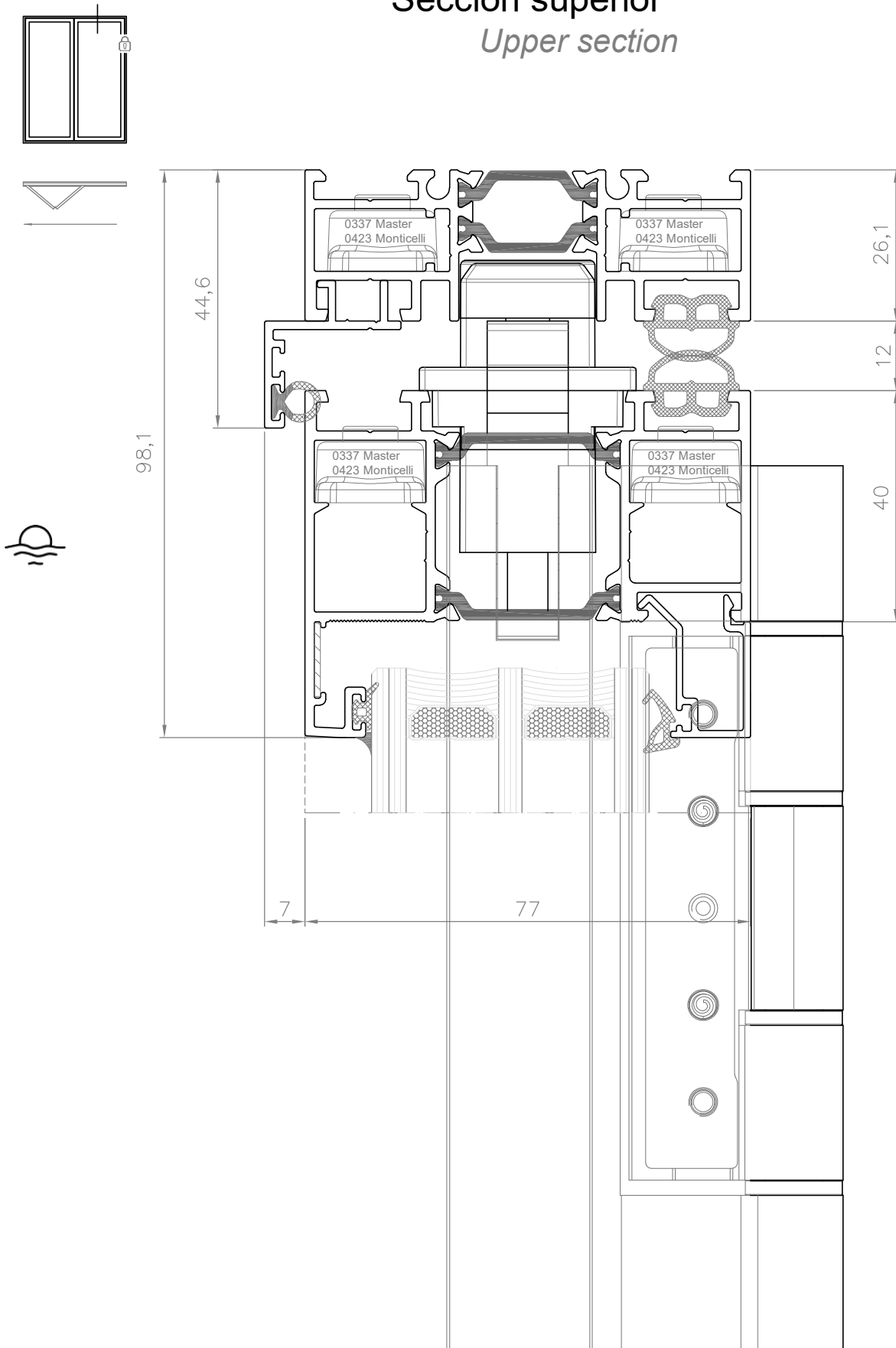

Sección lateral, bisagra  
*Lateral section, hinge*

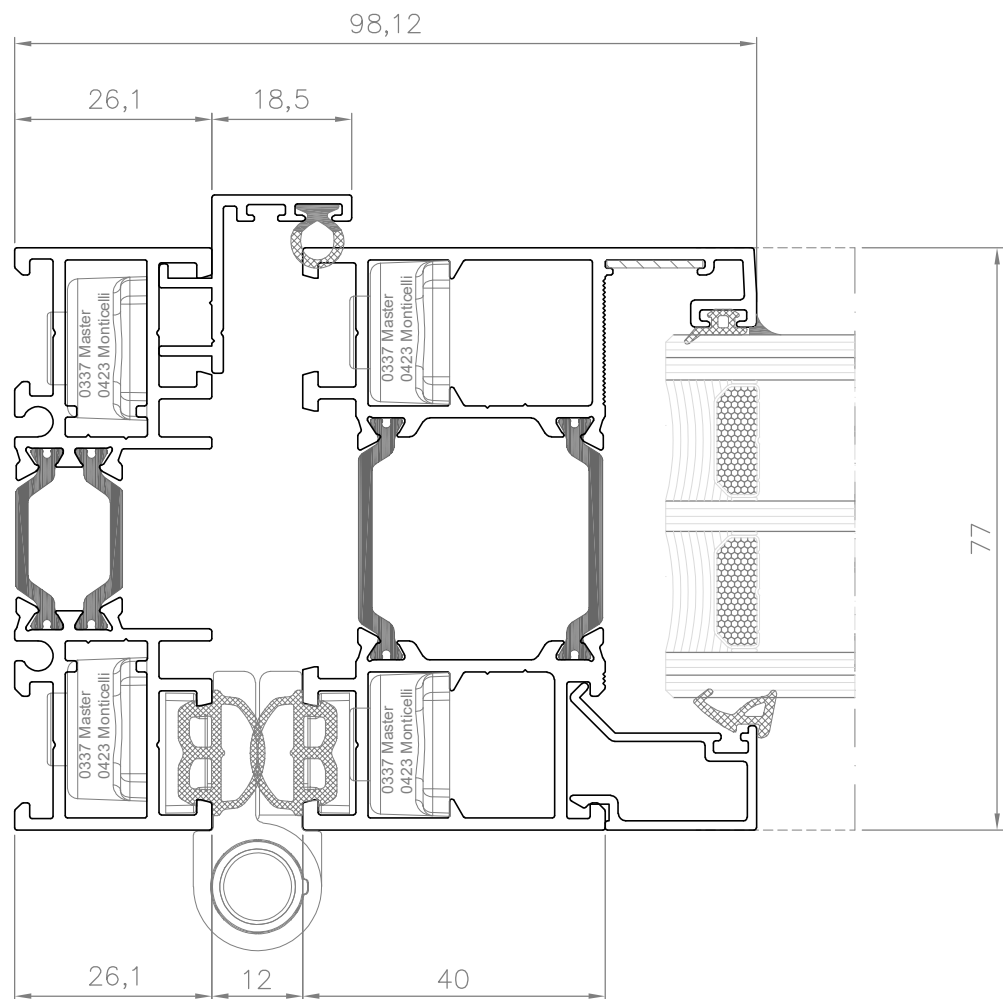
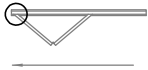
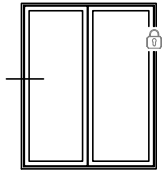



Sección lateral, cierre hojas pares  
*Lateral section, close paired sahes*

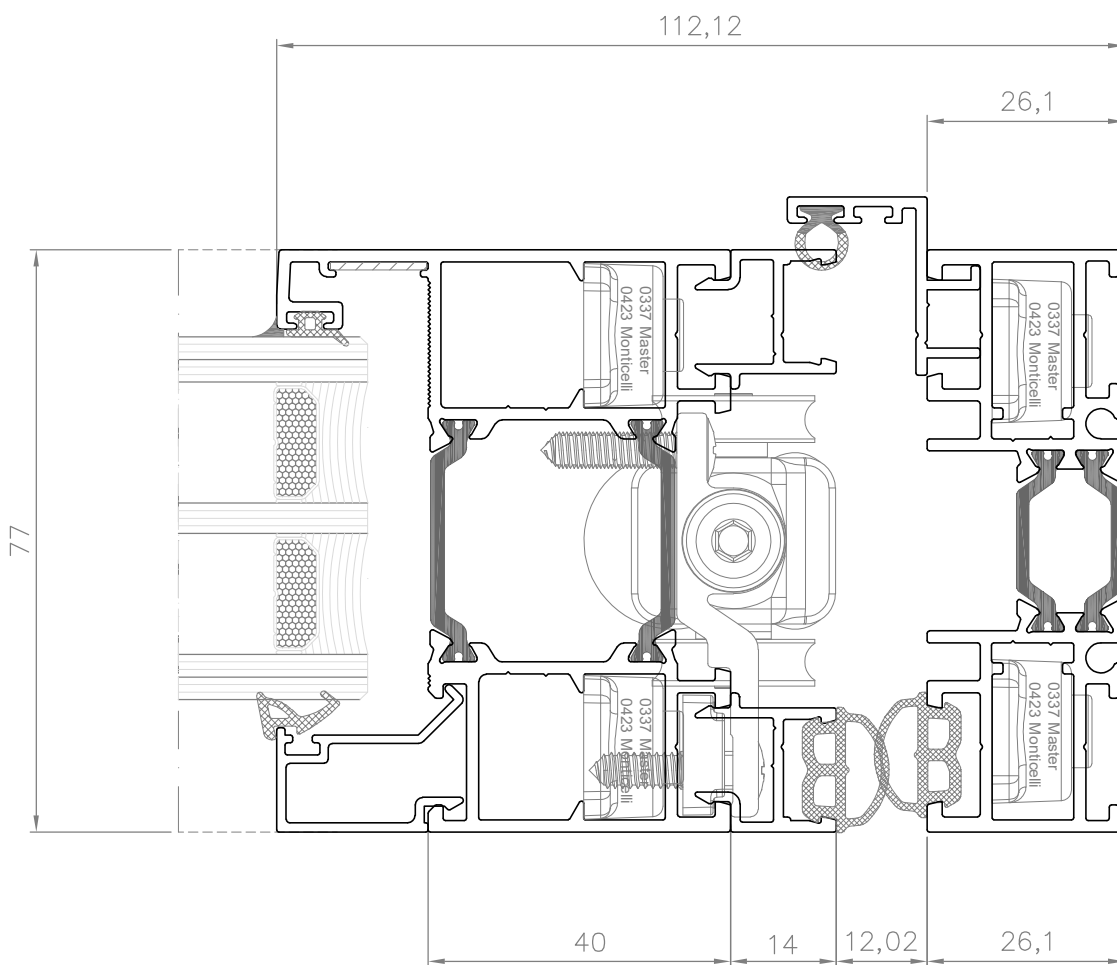
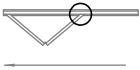
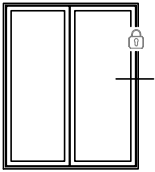

Sección lateral, cierre hoja batiente impar en marco  
*Lateral section, close odd sash supports on frame*

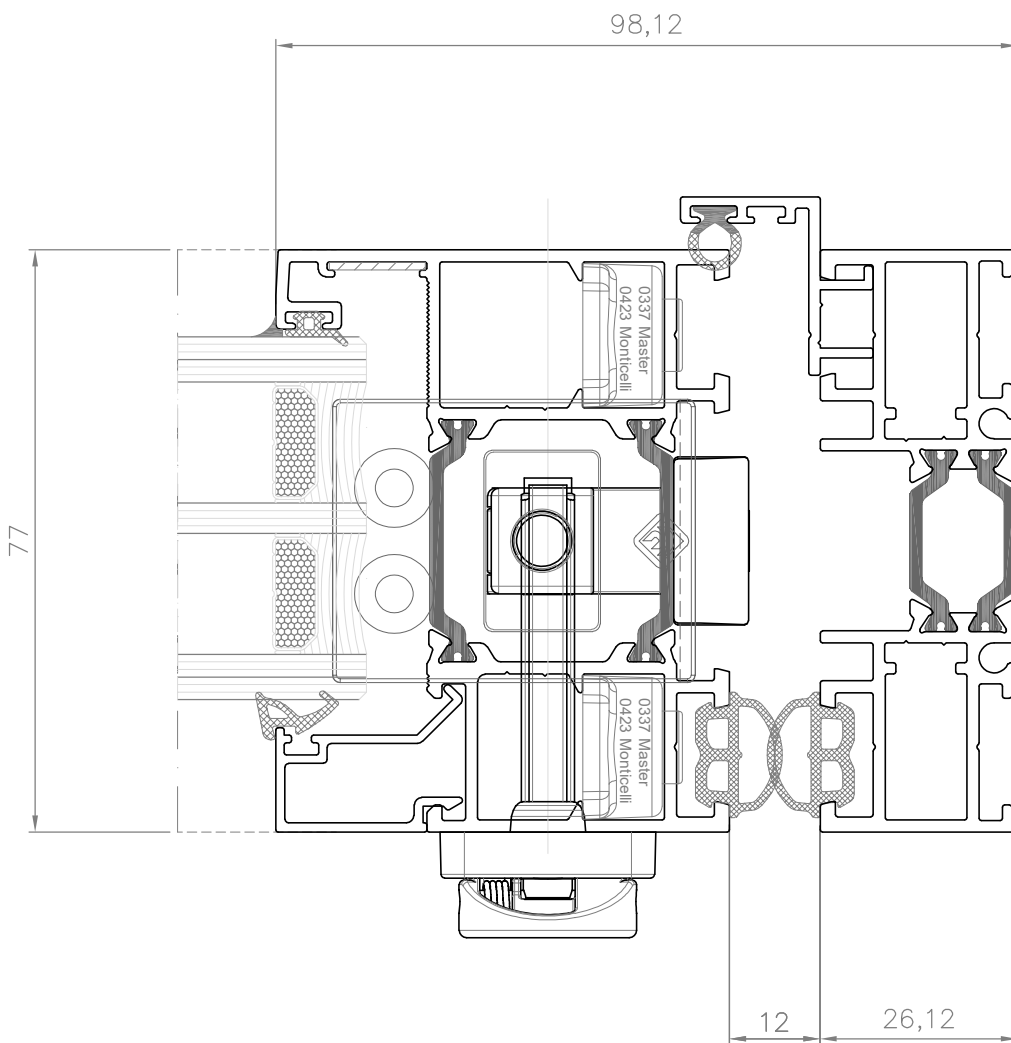
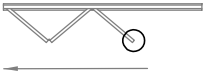
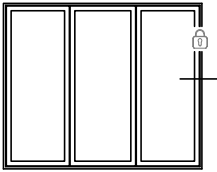

**Sección lateral, cierre hoja batiente impar en marco**  
*Lateral section, close odd sash supports on frame*

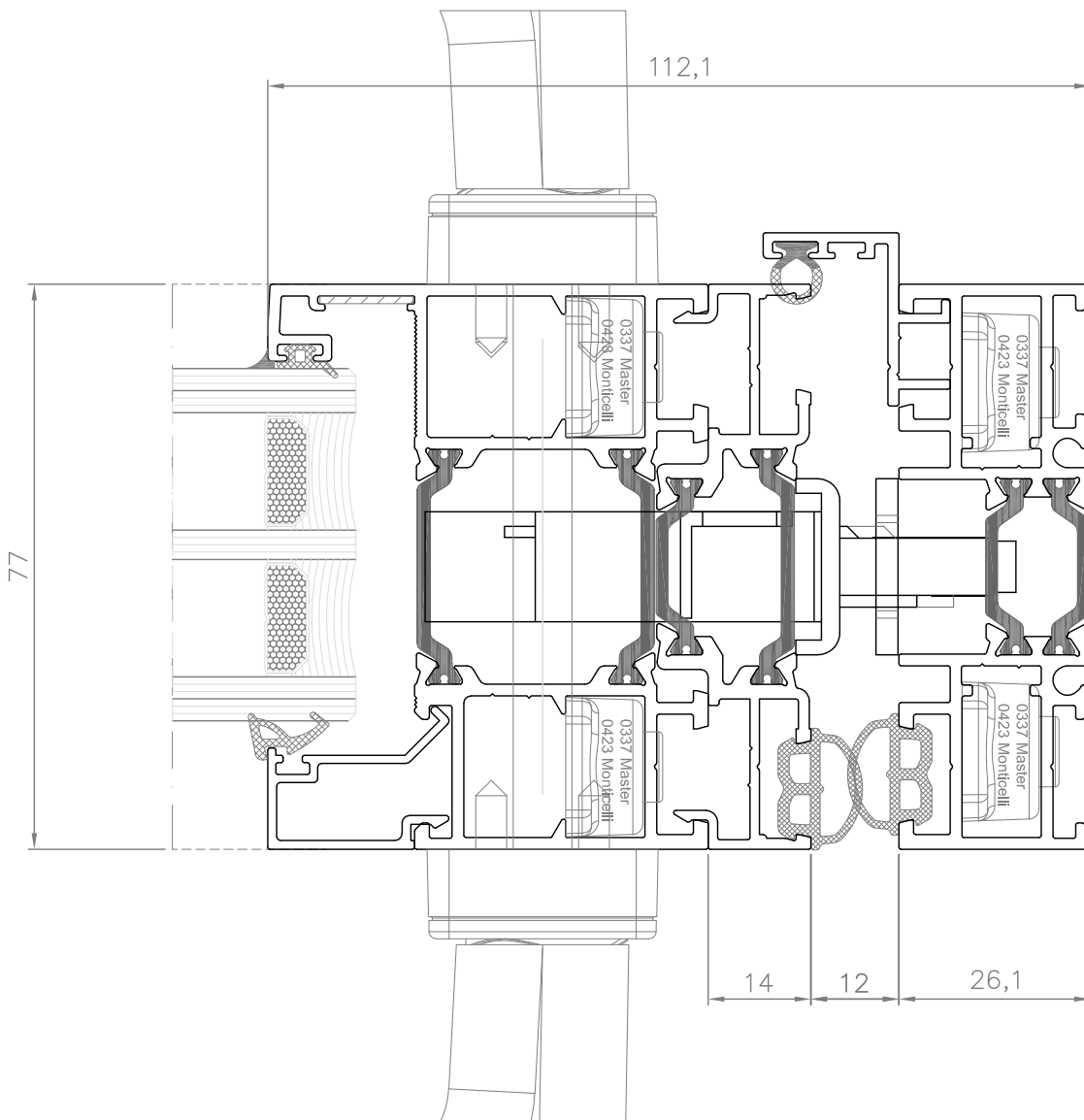
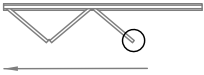
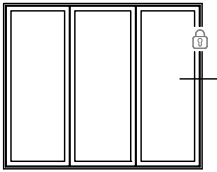

**Sección central, cierre hoja impar contra hoja par**  
*Central section, closing odd sash against even sash*

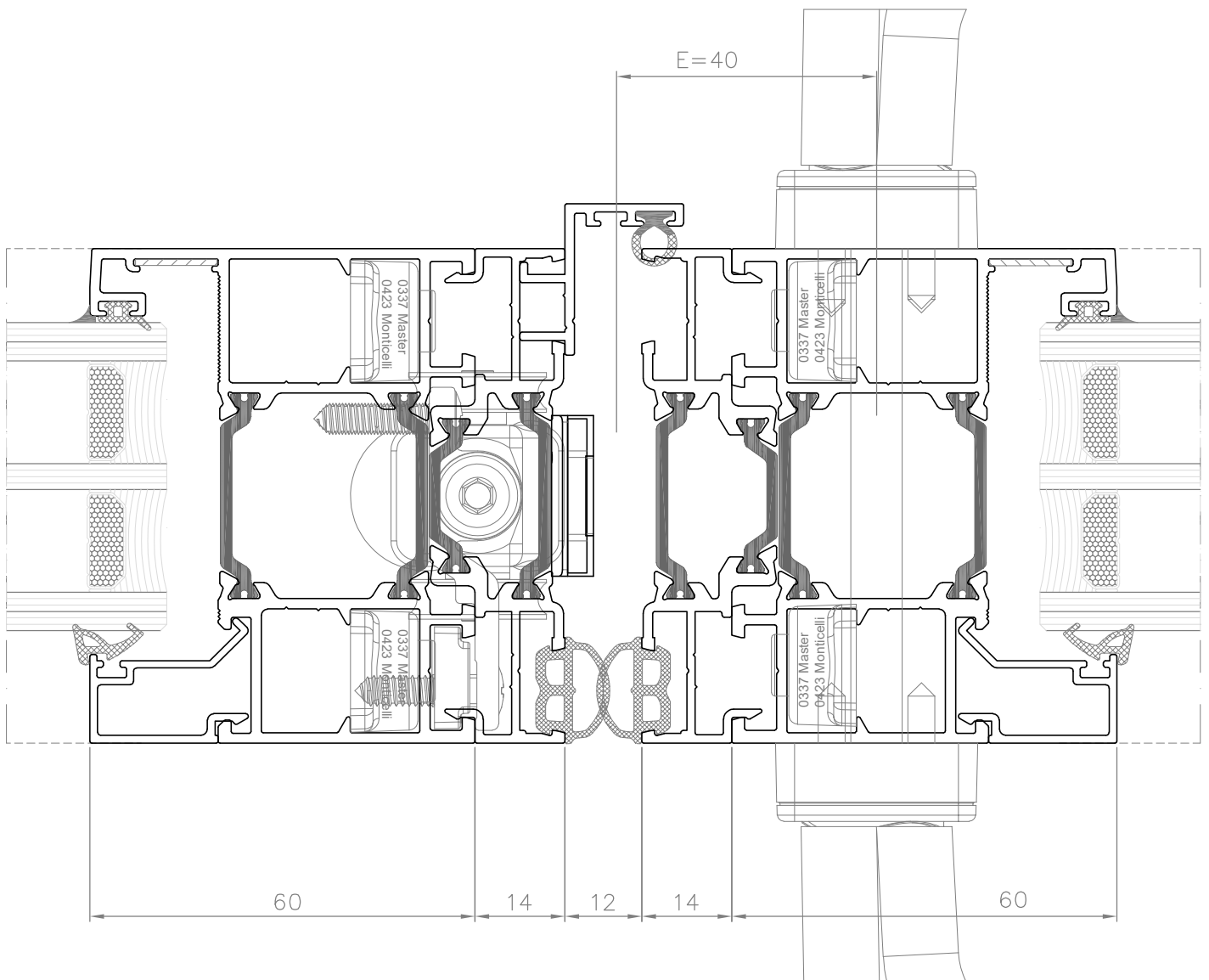
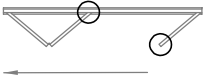
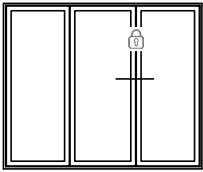

Sección central, carros en marcos  
*Central section, wheels on frames*

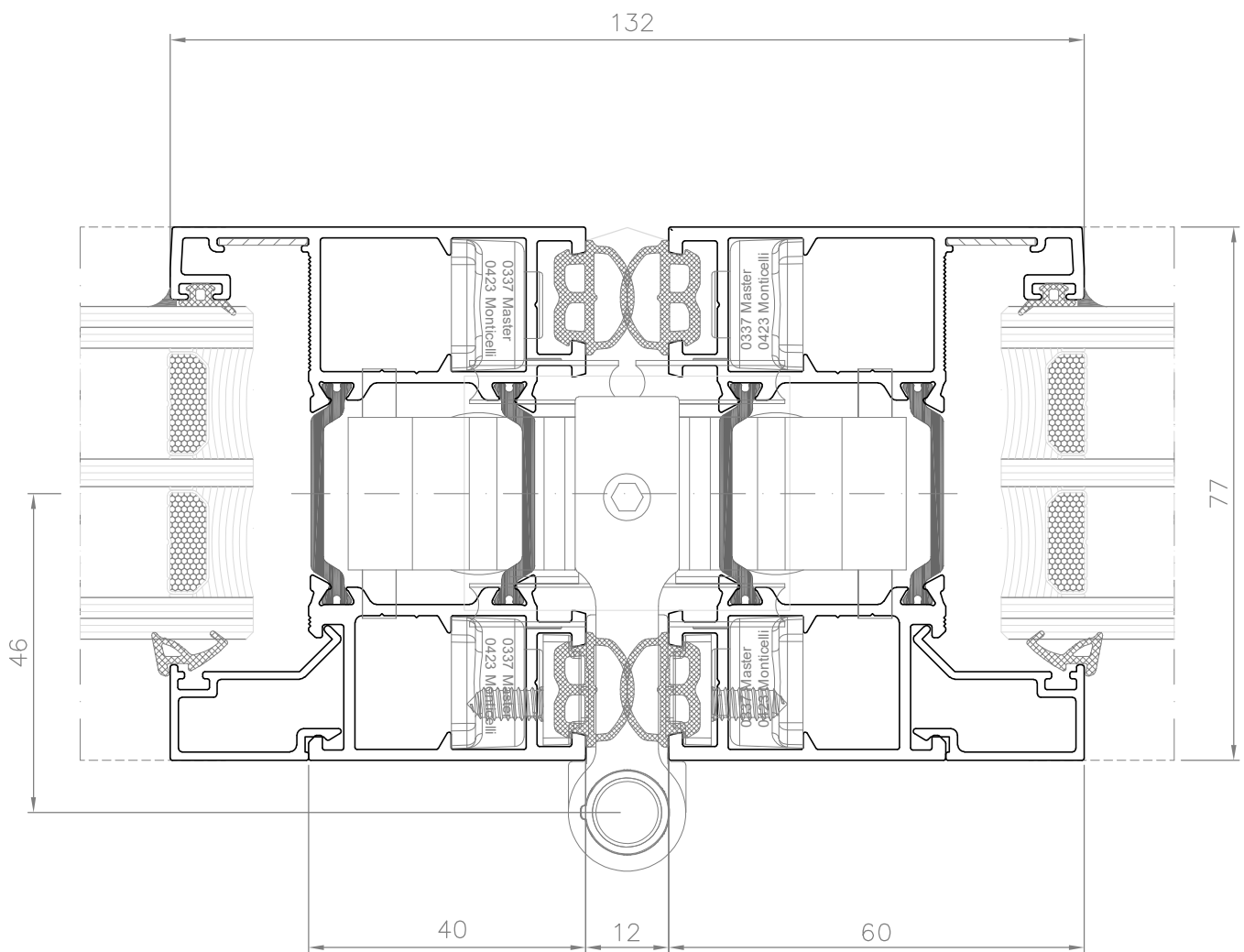
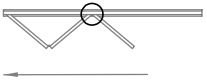
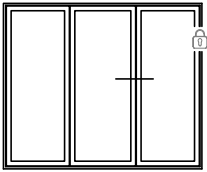

Sección central, bisagra  
*Central section, hinge*

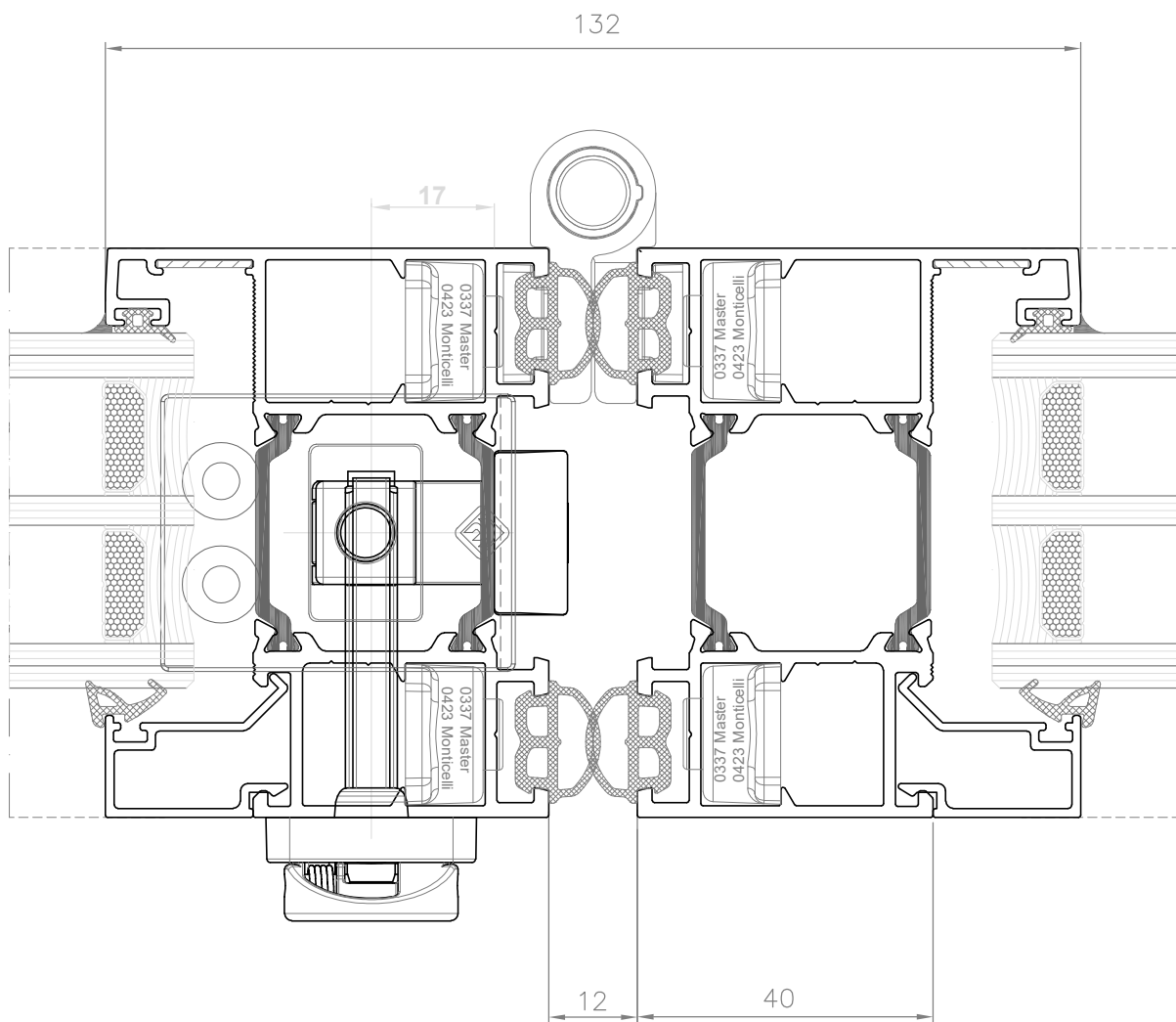
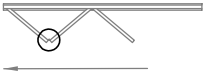
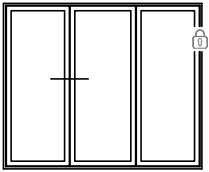

**Sección central, cierre hoja par contra hoja par**  
*Central section, closing even sash against even sash*

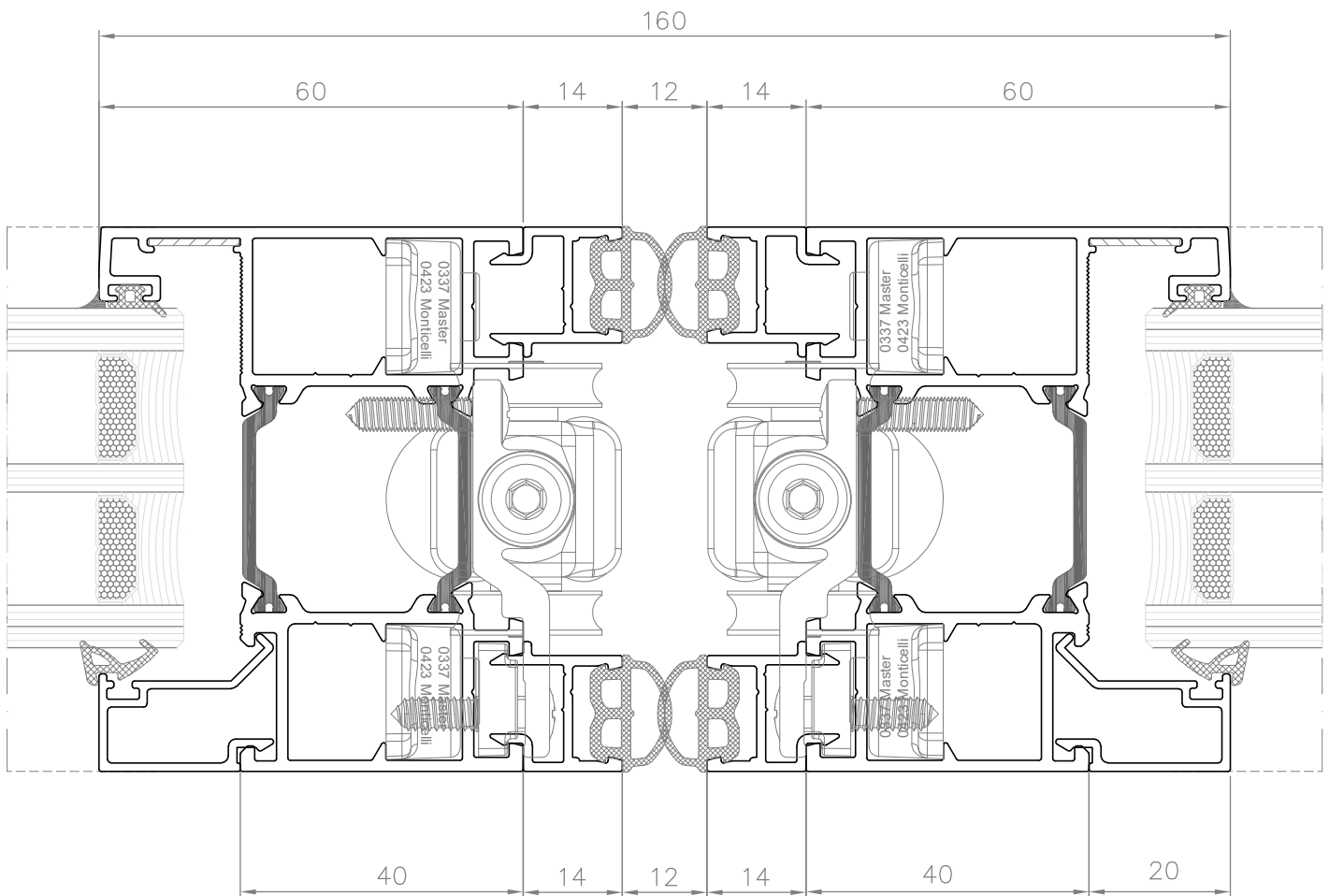
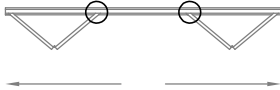
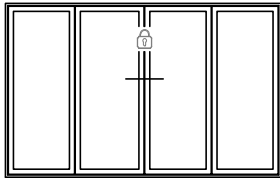

Sección central, cierre hoja impar contra hoja impar  
*Central section, closing odd sash against odd sash*

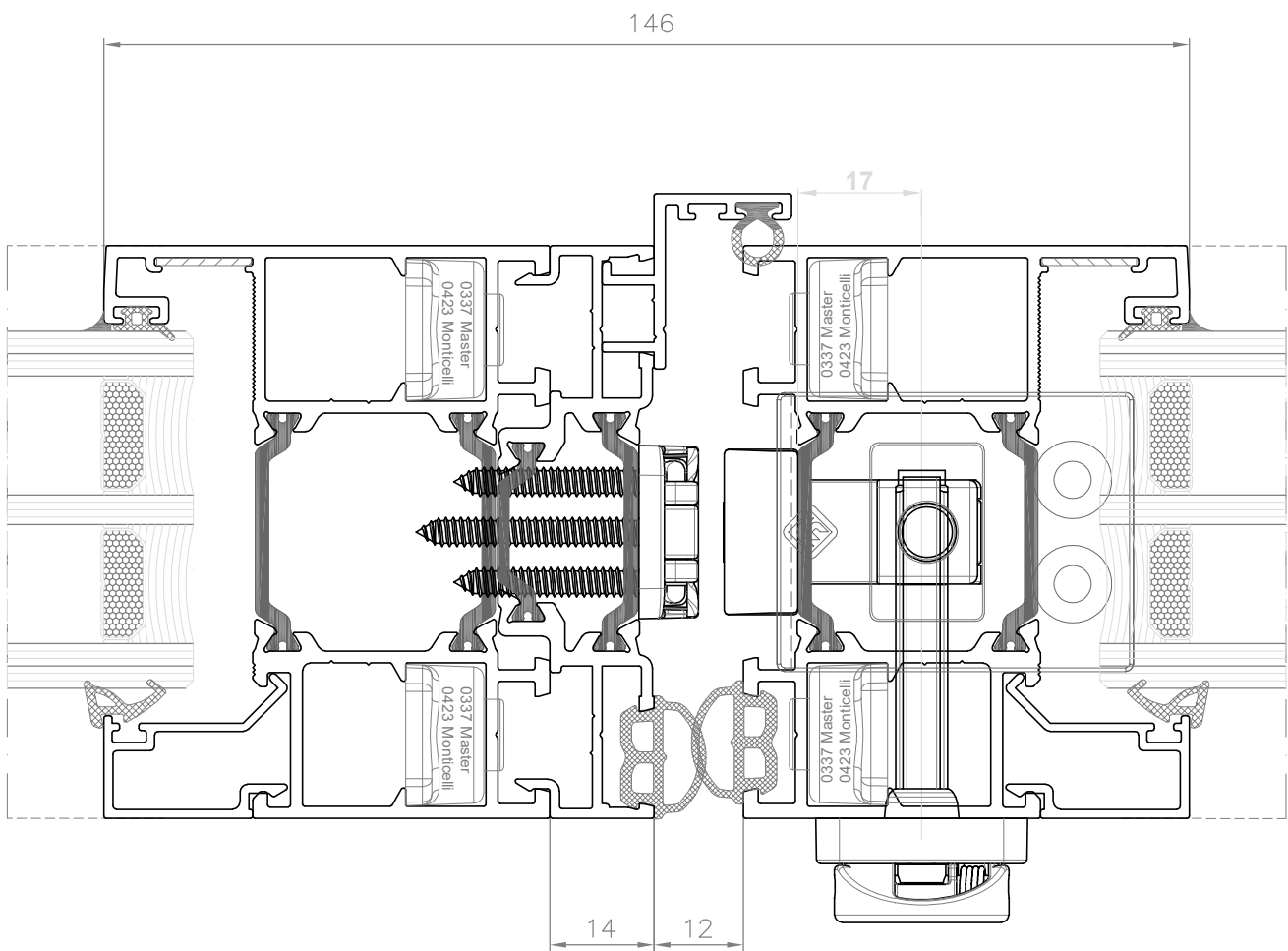
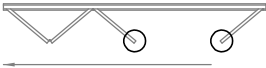
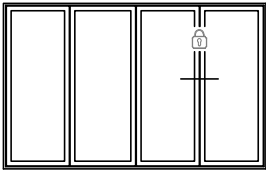



Sección central, cierre hoja impar contra hoja impar  
*Central section, closing odd sash against odd sash*

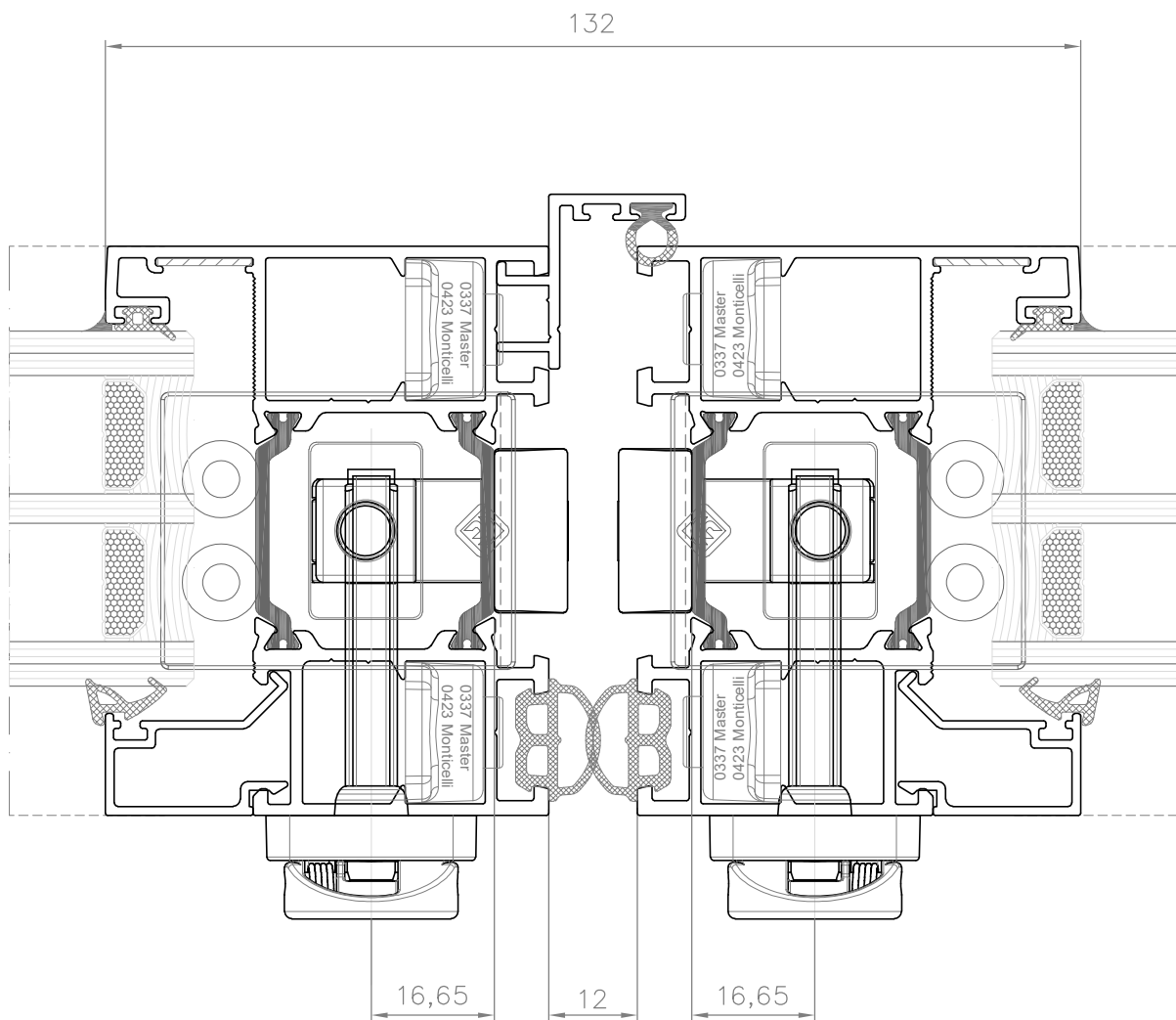
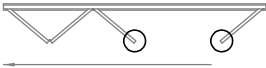
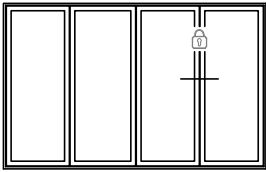

Sección central, cierre hoja impar contra hoja impar  
*Central section, closing odd sash against odd sash*

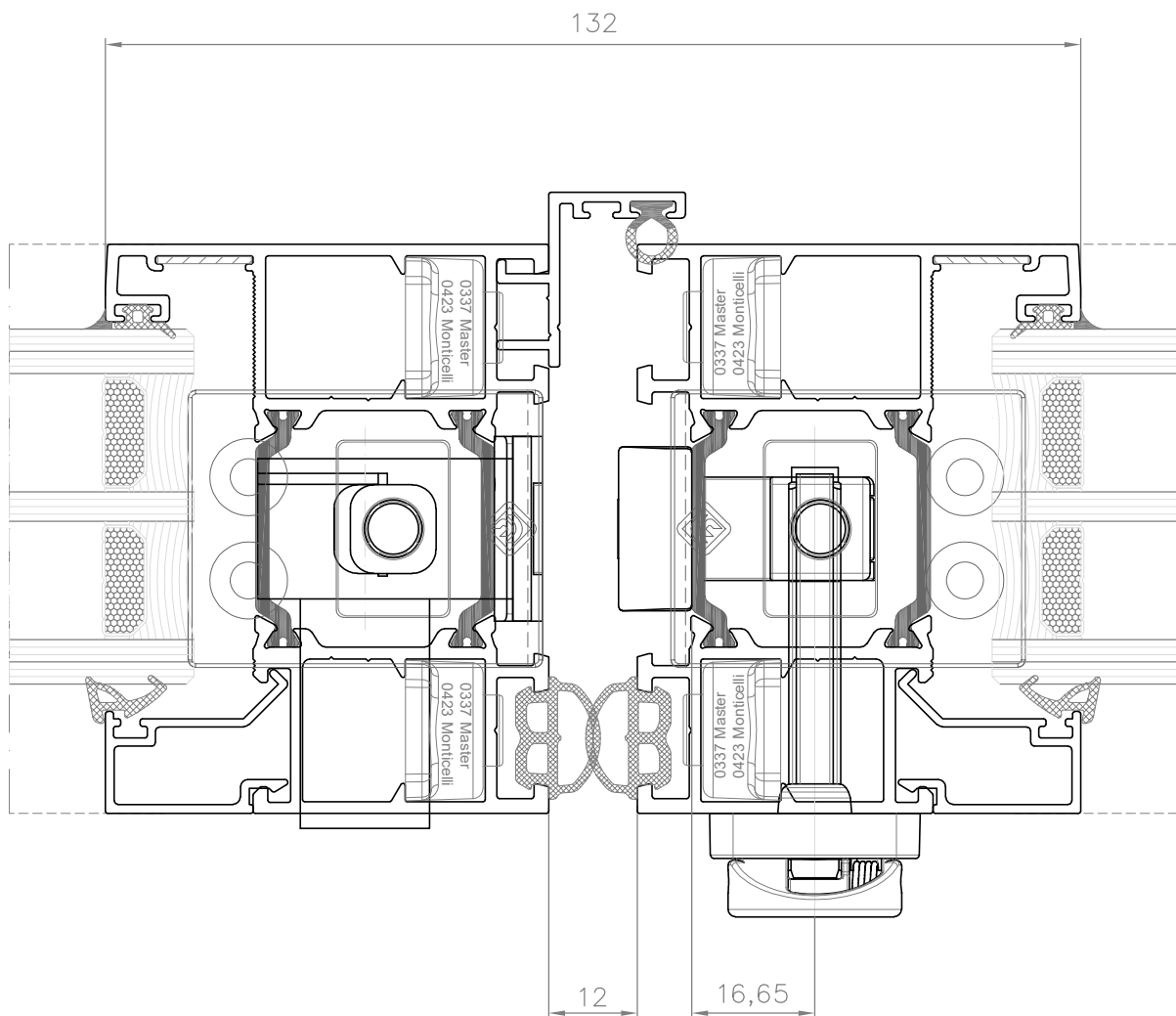
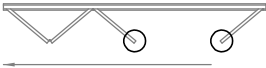
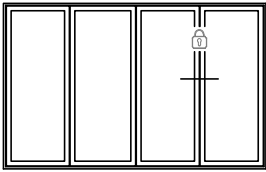

**Sección central, cierre hoja impar contra hoja impar**  
*Central section, closing odd sash against odd sash*

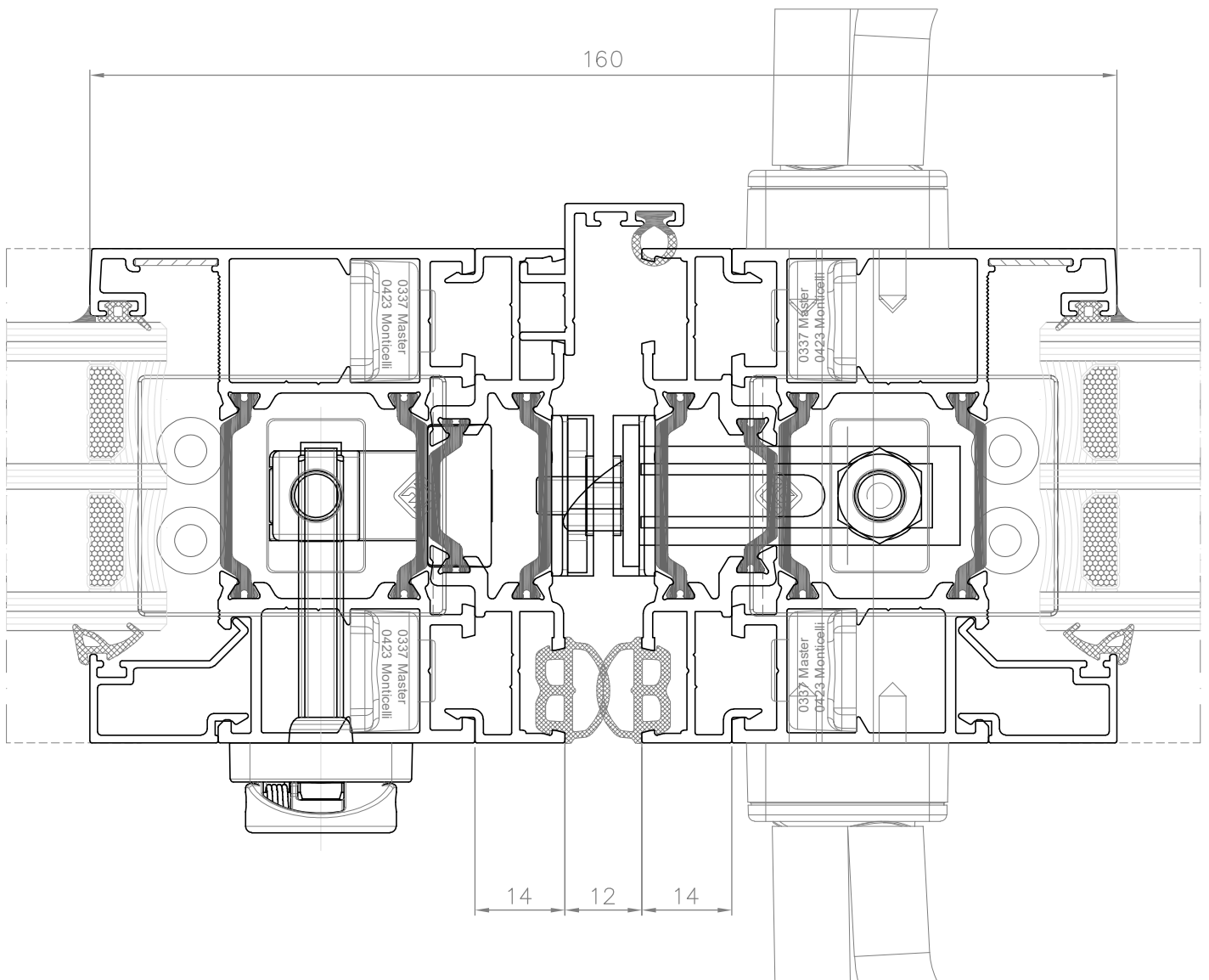
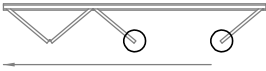
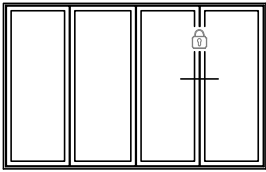

Sección central, cierre hoja impar contra hoja impar  
*Central section, closing odd sash against odd sash*

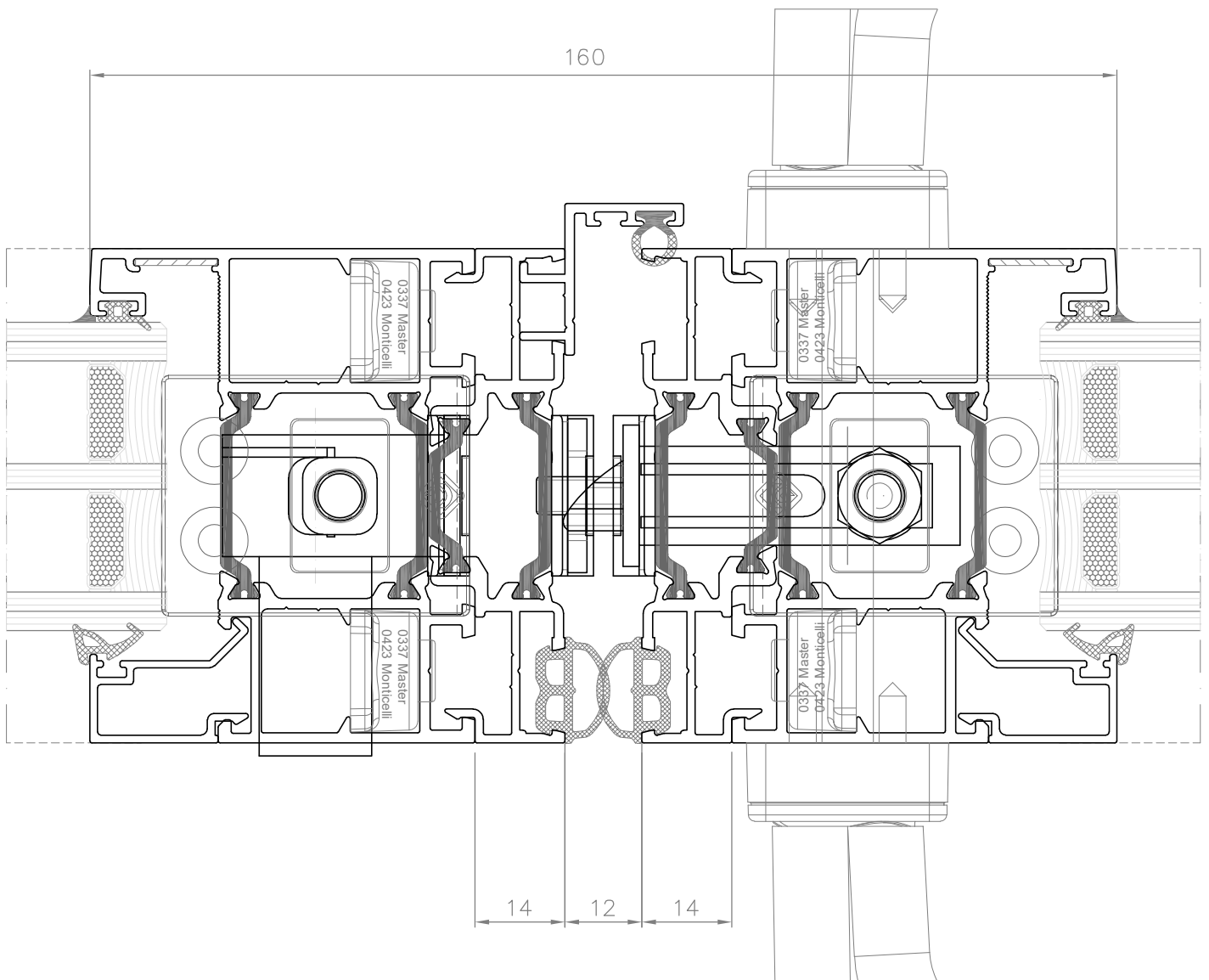
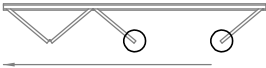
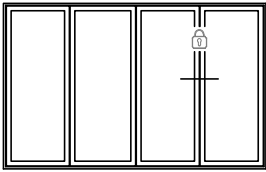

Sección central, cierre hoja impar contra hoja impar  
*Central section, closing odd sash against odd sash*

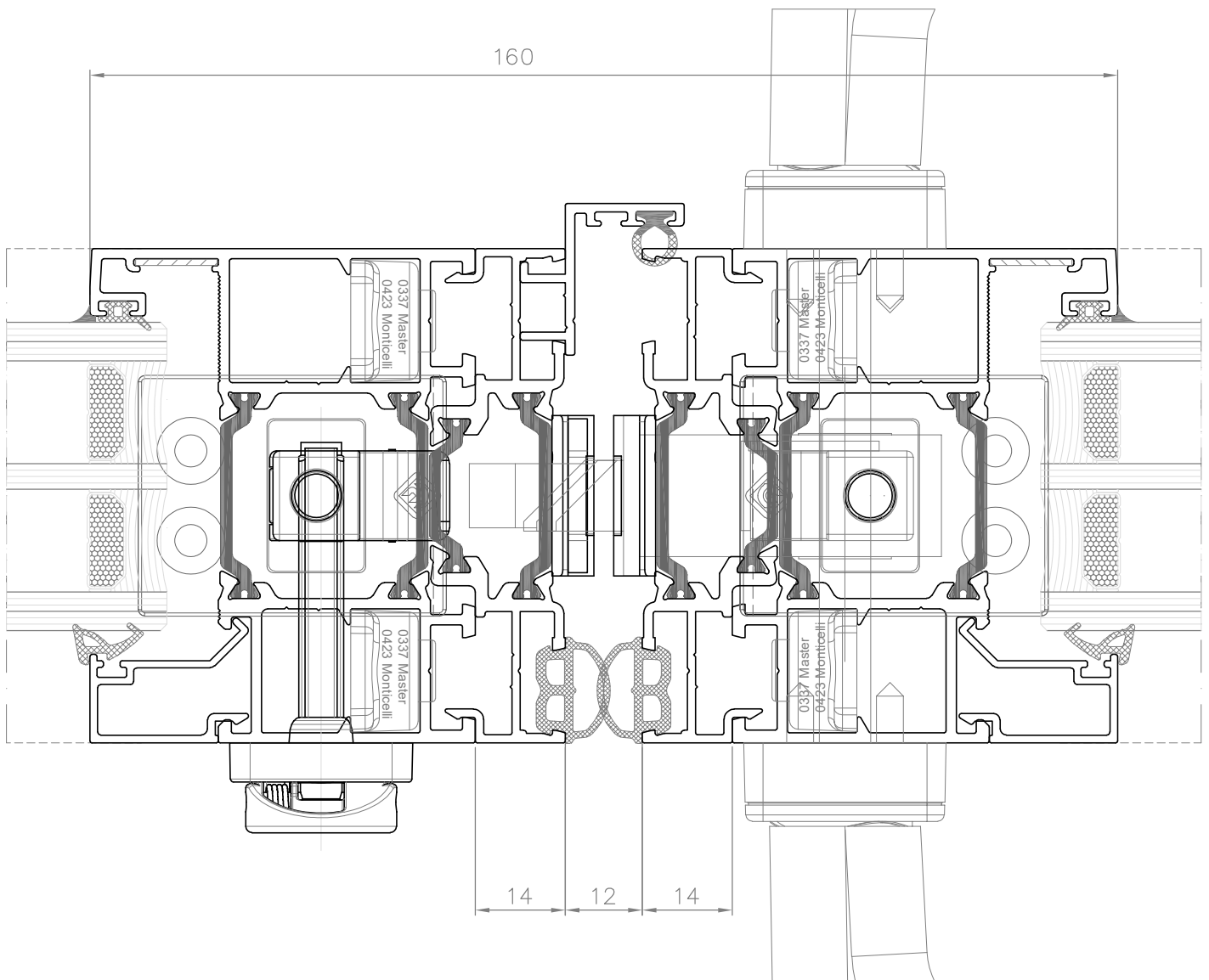
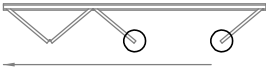
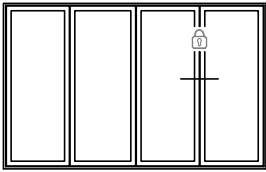

**Sección central, cierre hoja impar contra hoja impar**  
*Central section, closing odd sash against odd sash*

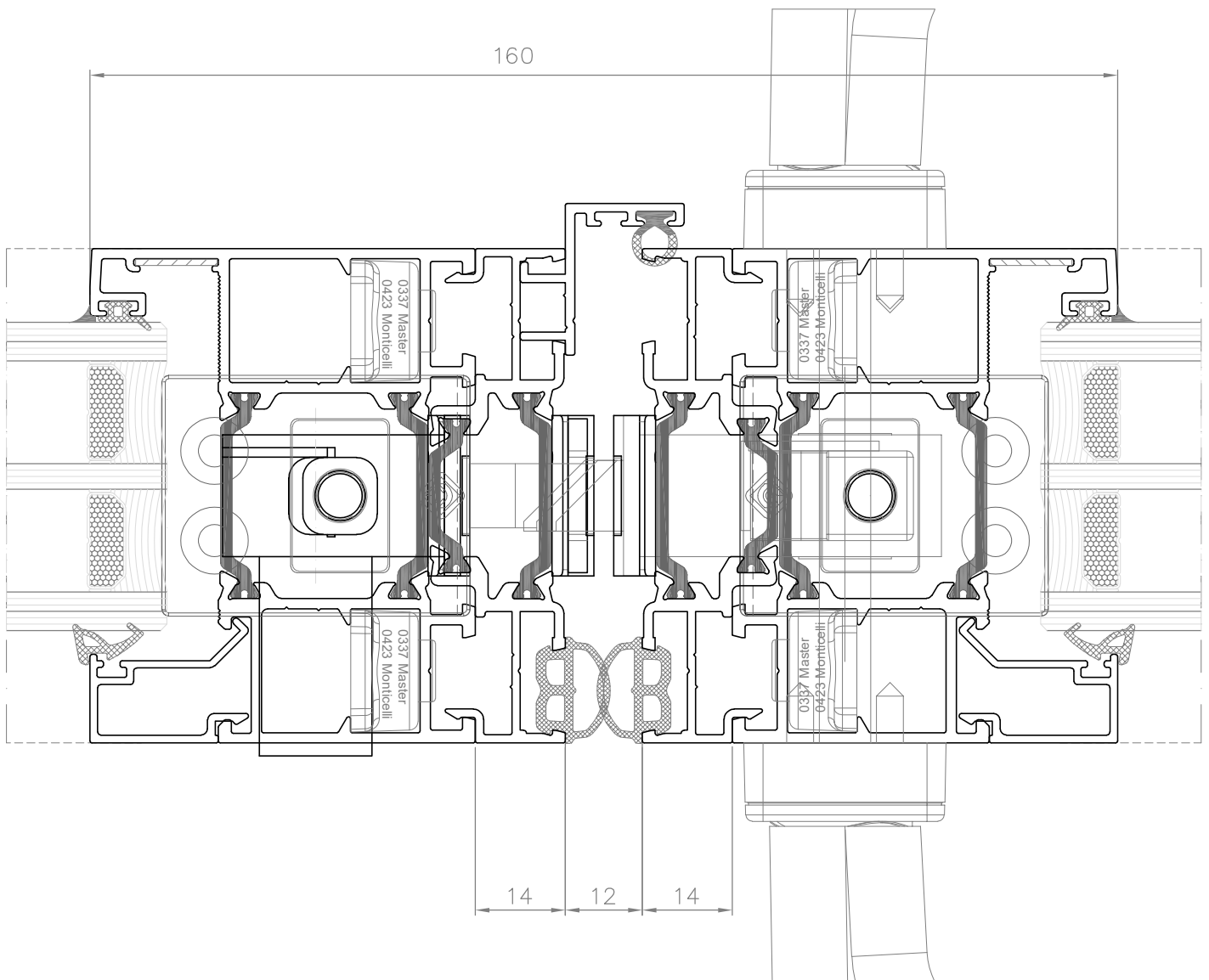
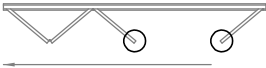
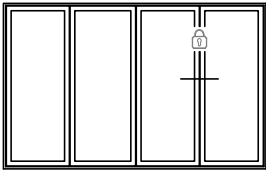

Sección central, cierre hoja impar contra hoja impar  
 Central section, closing odd sash against odd sash

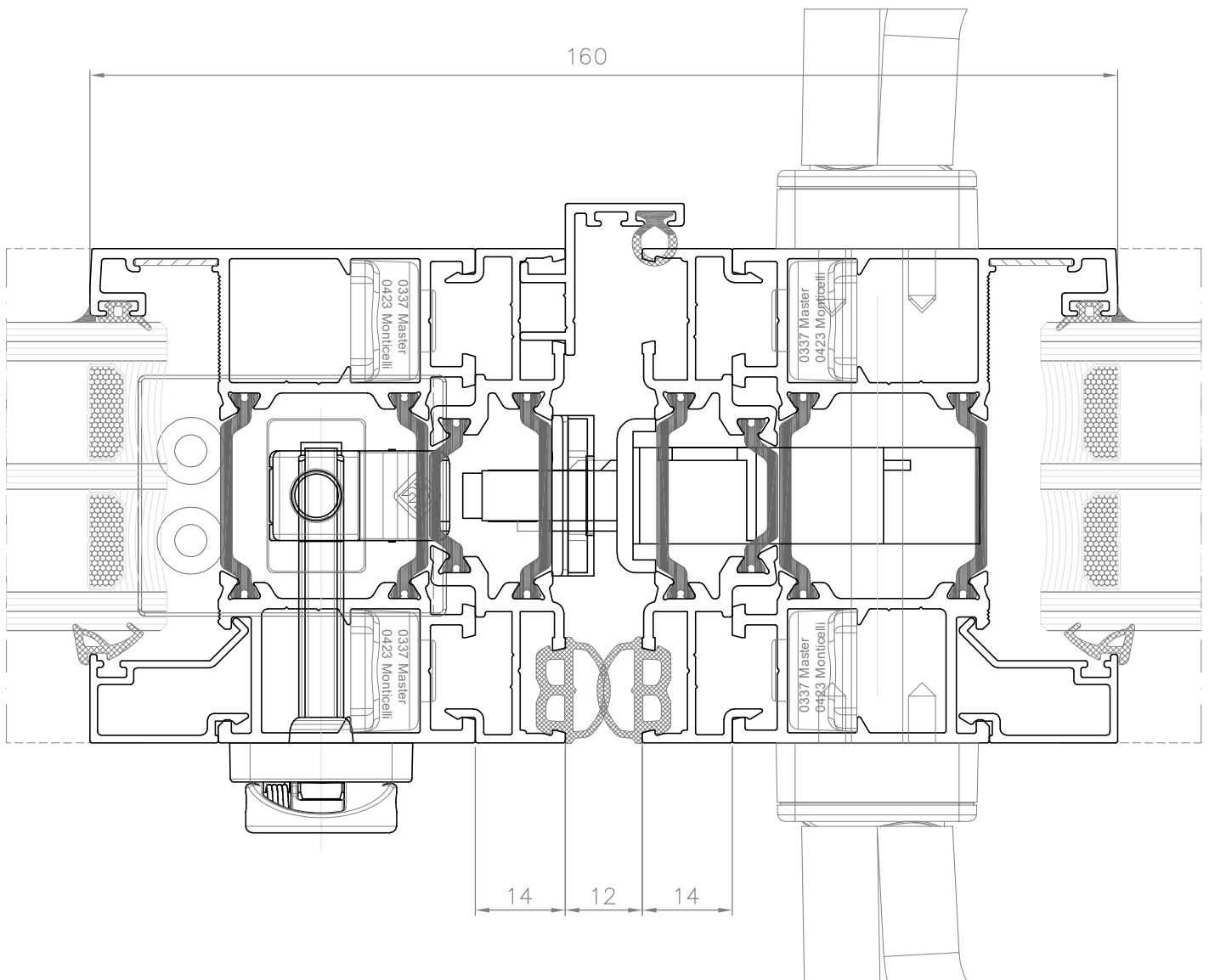
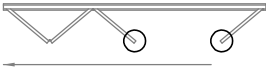
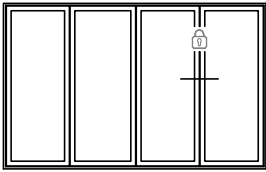

Sección central, cierre hoja impar contra hoja impar  
*Central section, closing odd sash against odd sash*

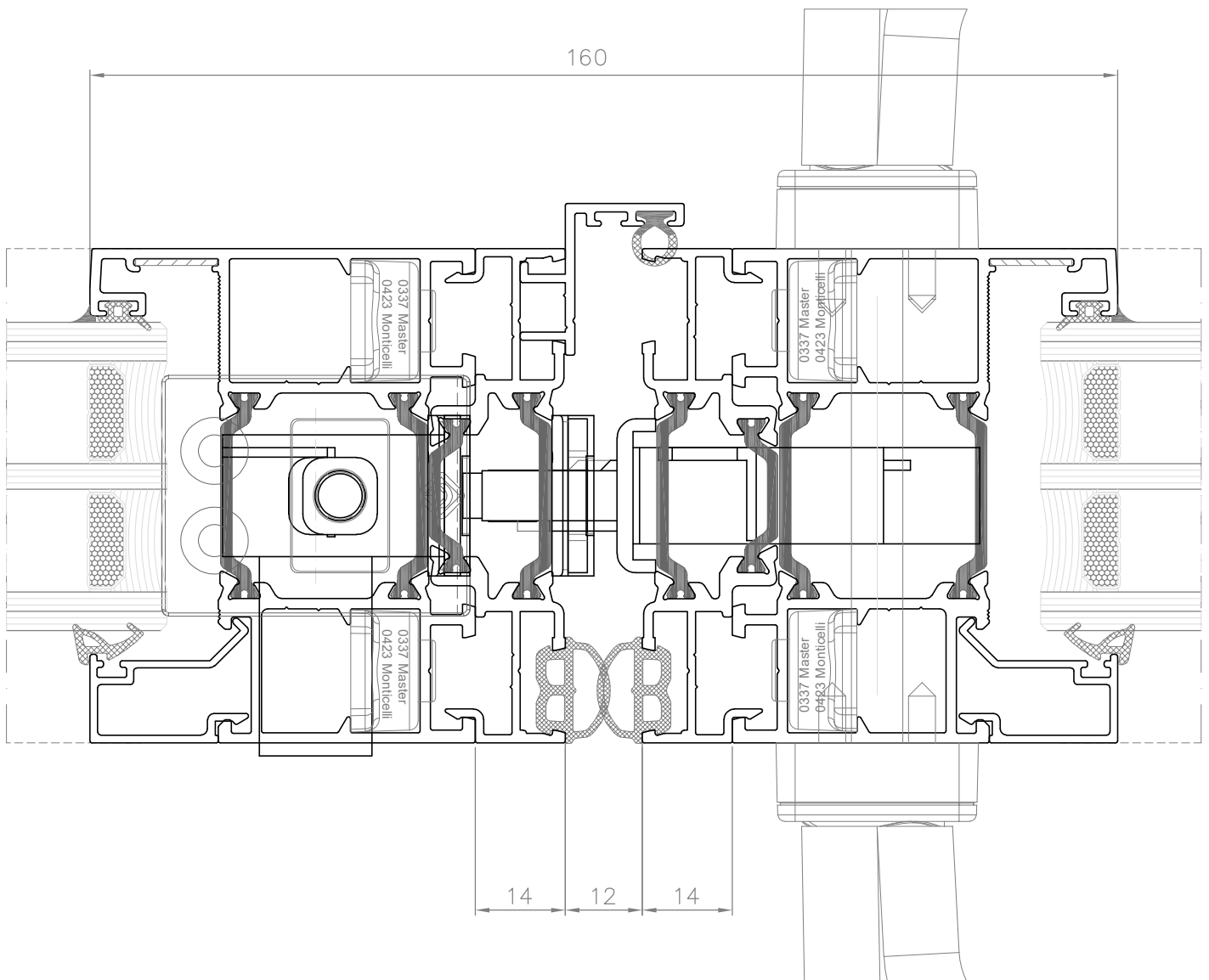
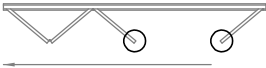
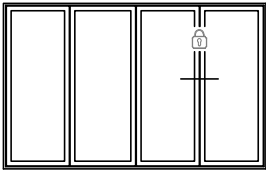



Sección inferior  
*Lower section*



90502

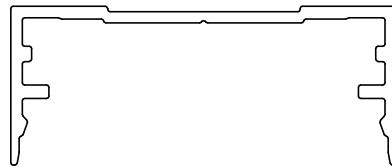

90502

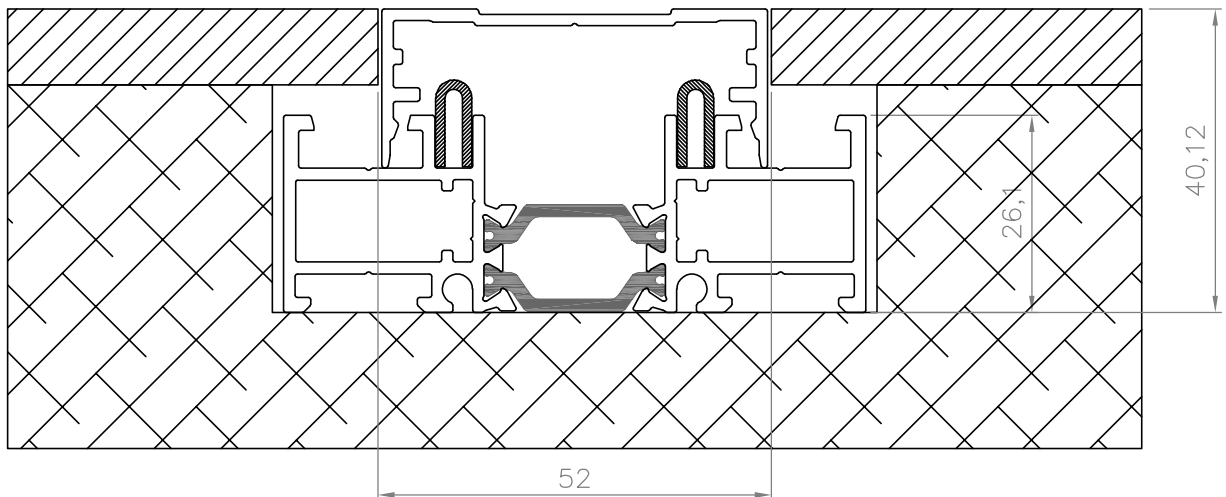

Sección inferior  
*Lower section*

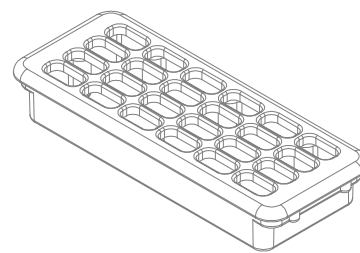
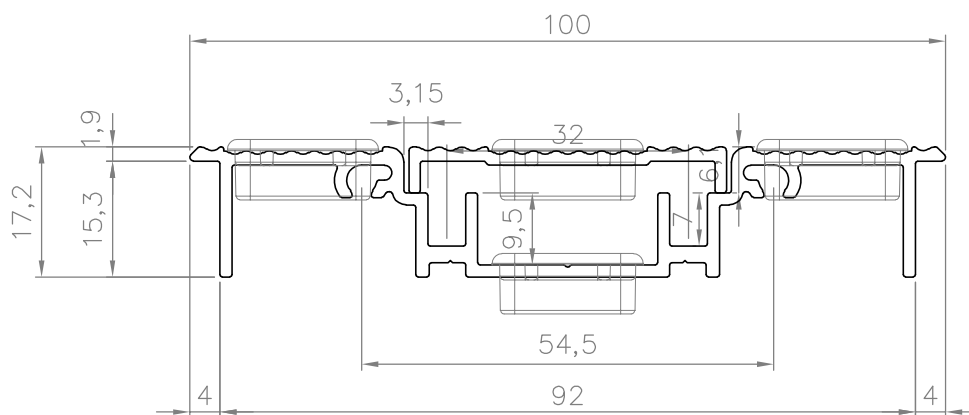



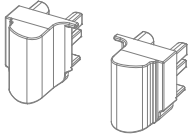
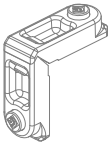
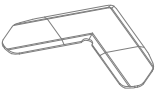
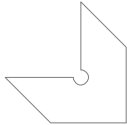
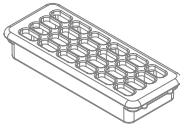

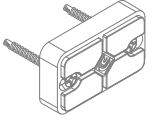

Accesorios | *Accessories*

Diseño   <i>Design</i>	Referencia   <i>Code</i>	Descripción   <i>Description</i>
	32337.4	Tapones unión para junta 35589100 <i>Plug for gasket corner 35589100</i>
	3A0337	Escuadra QS-XL <i>Pivoting QS-XL</i>
	30723	Escuadra de alineamiento 12,9 x 1 mm para hoja 79101 <i>Alignment pivoting 12,9 x 1 mm for sash 79101</i>
	3501501	Escuadra de alineamiento 12,9 x 1 mm para hoja 79101 <i>Alignment pivoting 12,9 x 1 mm for sash 79101</i>
	3701418	Tope travesaño ventana 14 mm, para travesaño 77002 y zócalo 77042 <i>European groove crosspiece joint 14 mm, for 77002 and 77042</i>
	3702618	Tope travesaño ventana 26 mm, para travesaño 77012 <i>European groove crosspiece joint 26 mm, for 77012</i>
	3704018	Tope travesaño ventana 40 mm, para travesaño 77022 <i>European groove crosspiece joint 40 mm, for 77022</i>
	36841.5	Rejilla desagüe, para solera enrasada 100 mm 79106 <i>Drain grate, for flush profile 100 mm 79106</i>

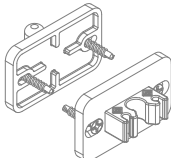

Herrajes | Hardware

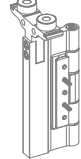
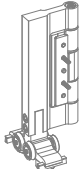
Diseño   Design	Referencia   Code	Descripción   Description
	32016.2	Guía Raíl de rodadura inoxidable, largo 3,25 m <i>Stainless steel rail, large 3,25 m</i>
	3626.10	Mecanismo bidireccional (int. 11,5 x 25 mm) + 2 guías + 2 adaptadores <i>Two-way movement</i>
	3626.42	Kit de cierre con adaptadores, terminales y varillas 2.000 mm <i>Locking rod kit</i>
	32411	Placa registro montaje *****
	32423	Tornillo regulación registro montaje 30 mm *****
	34227	Cerradero antipalanca <i>Universal additional locking</i>
	393638.5	Espesor para bloqueos 393638.6 y .7 <i>Thickness sash stopper 393638.6 and .7</i>
	*393638.6	Bloqueo entre hojas usando manilla 3094 <i>Sash stopper</i>

Herrajes | Hardware

Diseño   Design	Referencia   Code	Descripción   Description
	393638.7	<p>Bloqueo entre hojas usando línea Italia <i>Sash stopper</i></p>
	34501.10	<p>Pasador de palanca superior <i>Lever bolt with striker, upper</i></p>
	34504.10	<p>Pasador de palanca inferior <i>Lever bolt with striker, lower</i></p>
	34239	<p>Cerradero para pasadores con tapón cubrepolvo diám. 13 mm *****</p>
	38810.10	<p>Carro superior hojas plegables <i>Upper roller</i></p>
	38810.11	<p>Carro inferior hojas plegables <i>Lower roller</i></p>
	38811.10	<p>Carro superior hojas pares <i>Upper roller for even sash</i></p>
	38811.11	<p>Carro inferior hojas pares <i>Lower roller for even sash</i></p>

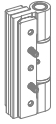
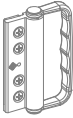
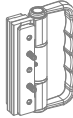
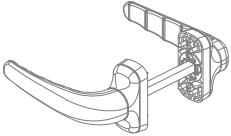
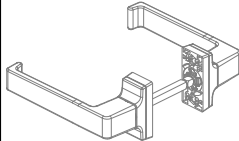
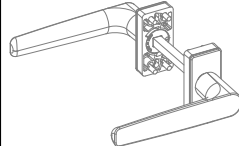

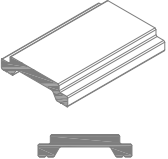

Herrajes | Hardware

Diseño   Design	Referencia   Code	Descripción   Description
	38815.12	Bisagra sistema plegable con placas de fijación <i>Hinge with inserting plate</i>
	38816.12	Bisagra de tiro con manilla tiradoras (interior) <i>Pulling hinge (internal opening)</i>
	38816.14	Bisagra de tiro con manilla tiradoras (exterior) <i>Pulling hinge (external opening)</i>
	3063	Doble manilla línea COMFORT, una manilla std. + rebajada (sólo para cerradura en hoja par) <i>Double handle COMFORT, one handle std. + reduced (for even sash lock)</i>
	3065	Doble manilla línea ITALIA con cuadradillo 8 mm, para cerradura <i>Double handle ITALIA with square axis 8 mm, for lock</i>
	3067	Doble manilla línea KARMA con cuadradillo 8 mm, para cerradura <i>Double handle KARMA with square axis 8 mm, for lock</i>
	3106.30	Maneta rebajada línea KARMA con cuadradillo 7 mm <i>Reduced handle KARMA with square axis 7 mm</i>
	303524590N	Pletina de poliamida 15-20 (200 m) <i>Polyamide espagnolette deck 15-20 (200 m)</i>

Herrajes | Hardware

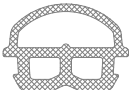
Diseño   Design	Referencia   Code	Descripción   Description
	34230P353AI	<p>Cerradura de Entrada 35 mm - 2230P/35 R13,2 <i>Latch lock E-35 mm</i></p>
	352005050N	<p>Cilindro 50 x 50 <i>Cylinder 50 x 50</i></p>
	3E24000NE	<p>Escudo de seguridad E210 <i>Security cylinder trim</i></p>

Juntas | Joints

Diseño   Design	Referencia   Code	Descripción   Description
	32158	<p>Junta exterior marco <i>Outer frame joint</i></p>
	35589100	<p>Junta EPDM hoja y marco QS-XL <i>Sash and frame joint QS-XL</i></p>
	35576600	<p>Junta inferior EPDM para marco 79100 embutido <i>Lower joint EPDM for frame 79100</i></p>
	32317	<p>Junta interior hoja espuma <i>Inner joint sash, foam</i></p>
	3708500001	<p>Felpa con lámina FS 7 x 8,5 mm <i>Felt FS 7 x 8,5 mm</i></p>
	32880288	<p>Felpa con lámina FS 7 x 19 mm <i>Felt FS 7 x 19 mm</i></p>



Juntas | Joints

Diseño   Design	Referencia   Code	Descripción   Description
	3442A30001	<p>Junta base acristalado 1 mm <i>Outer glazing joint 1 mm</i></p>
	32155	<p>Junta acristalamiento exterior 2,5 mm <i>Outer glazing joint 2,5 mm</i></p>
	32021	<p>Junta acristalamiento interior 2,5 / 3,5 mm <i>Inner glazing joint 2,5 / 3,5 mm</i></p>
	31987	<p>Junta acristalamiento interior 3,5 / 4,5 mm <i>Inner glazing joint 3,5 / 4,5 mm</i></p>
	3805	<p>Junta acristalamiento interior 4,5 / 5,5 mm <i>Inner glazing joint 4,5 / 5,5 mm</i></p>
	31849	<p>Junta acristalamiento interior 6 / 8 mm <i>Inner glazing joint 6 / 8 mm</i></p>

Utillajes | Tooling

Diseño   <i>Design</i>	Referencia   <i>Code</i>	Descripción   <i>Description</i>
	4T1703	Troquel QS-XL QS-XL tooling

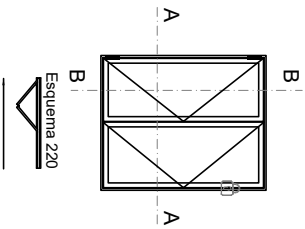

SECCIÓN A-A  
EN POSICIÓN CERRADA

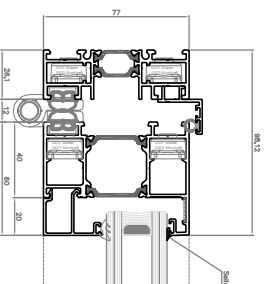

EXTERIOR

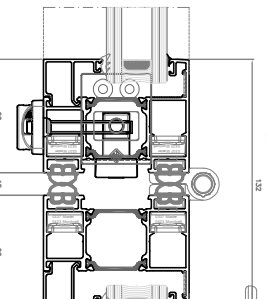

INTERIOR

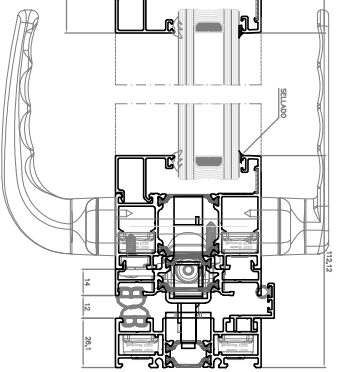

SECCIÓN A-A  
EN POSICIÓN ABIERTA

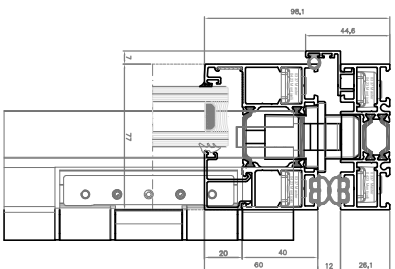
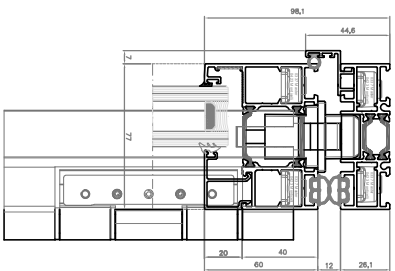

EXTERIOR

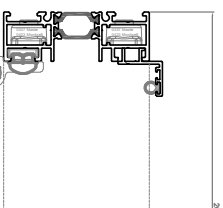

INTERIOR

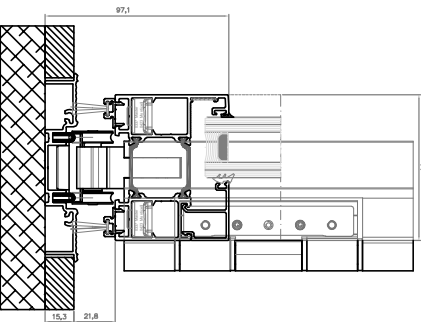
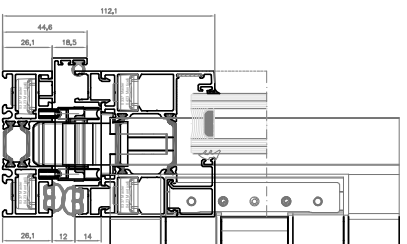
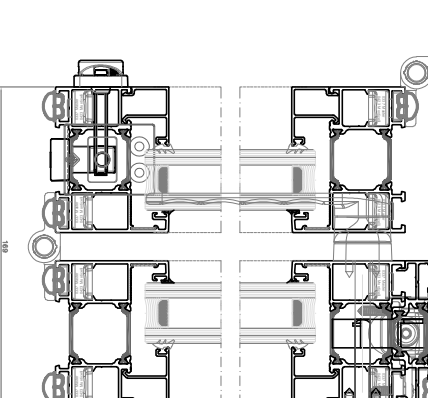

SECCIÓN B-B

### SECCIÓN A-A EN POSICIÓN CERRADA

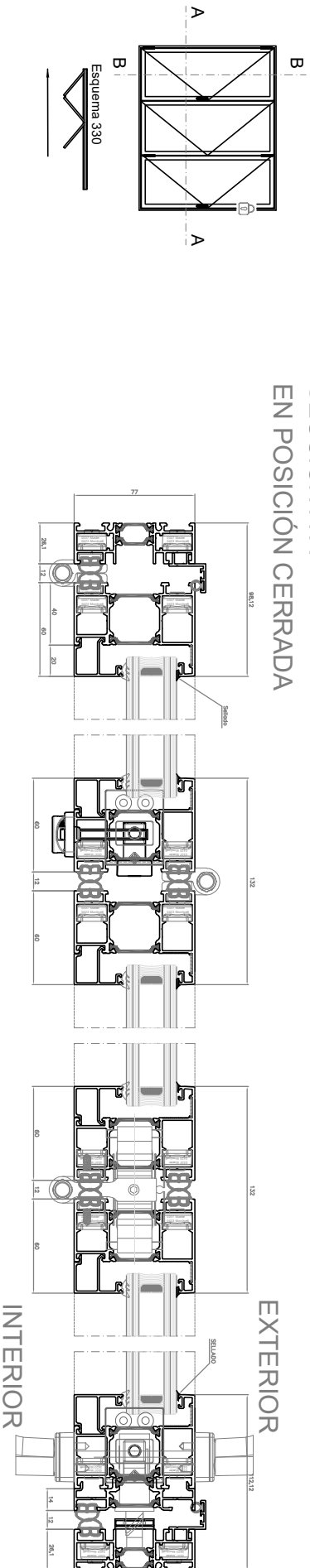

### SECCIÓN A-A EN POSICIÓN ABIERTA

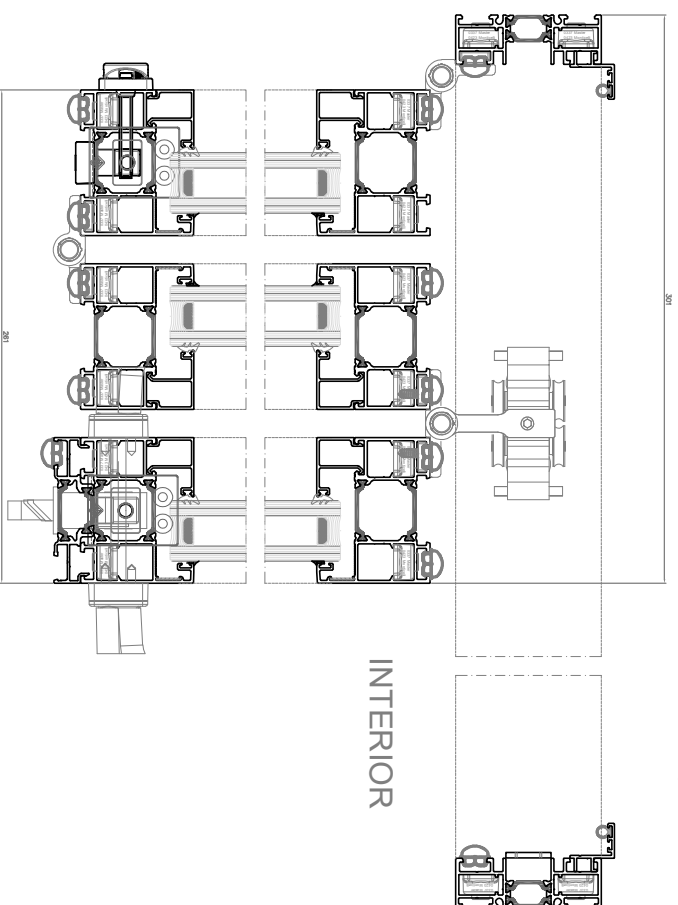

EXTERIOR

INTERIOR

### SECCIÓN B-B

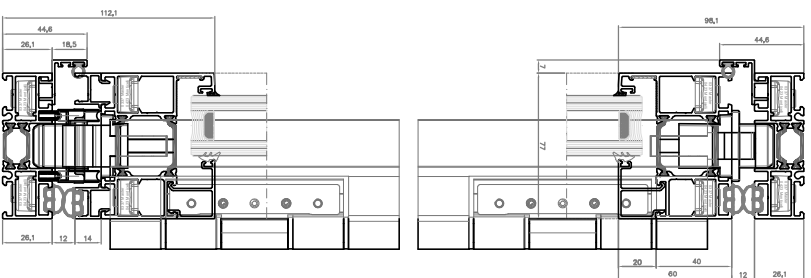
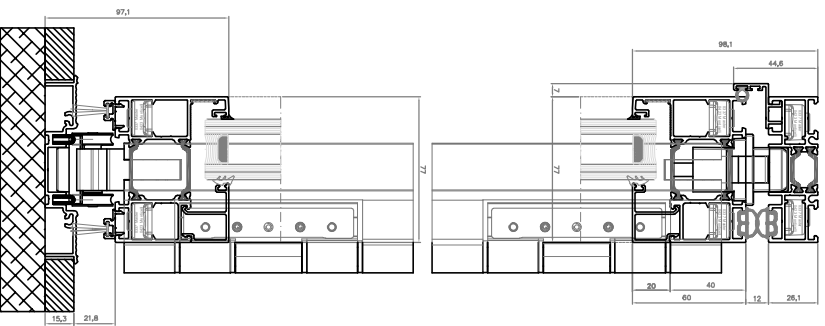

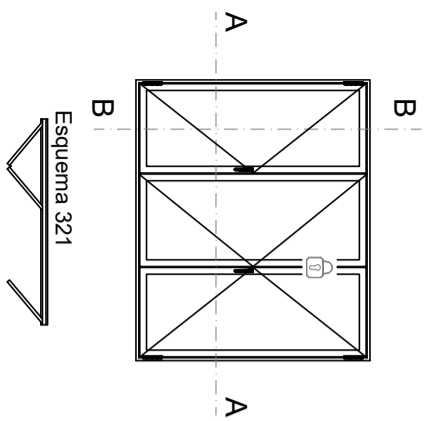

SECCIÓN A-A  
EN POSICIÓN CERRADA

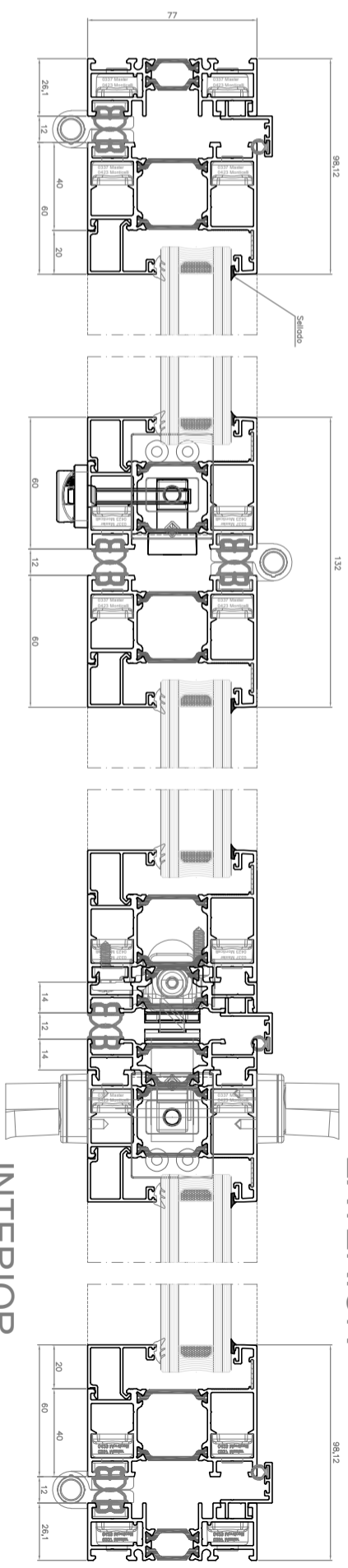

EXTERIOR

INTERIOR

SECCIÓN A-A  
EN POSICIÓN ABIERTA

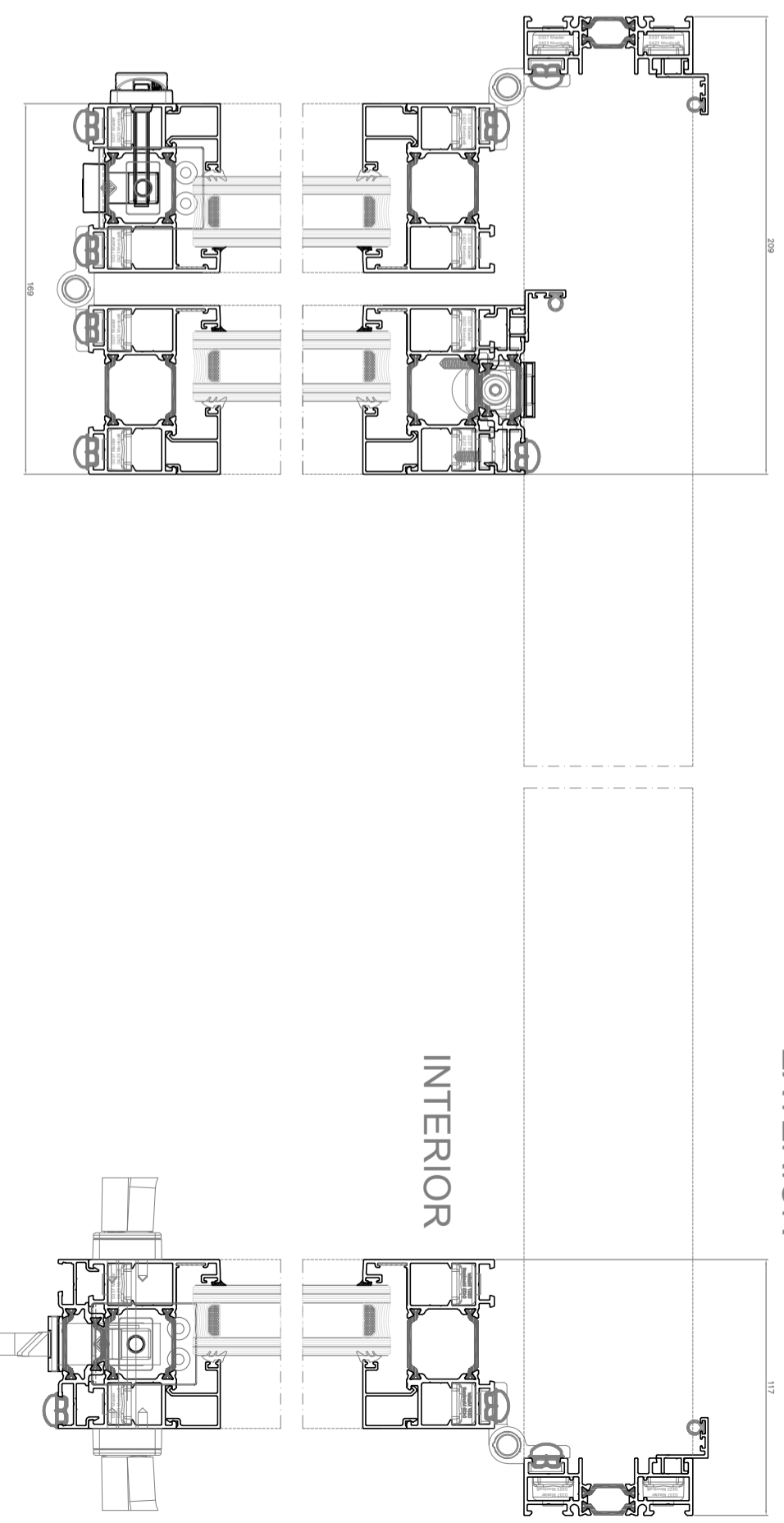

EXTERIOR

INTERIOR

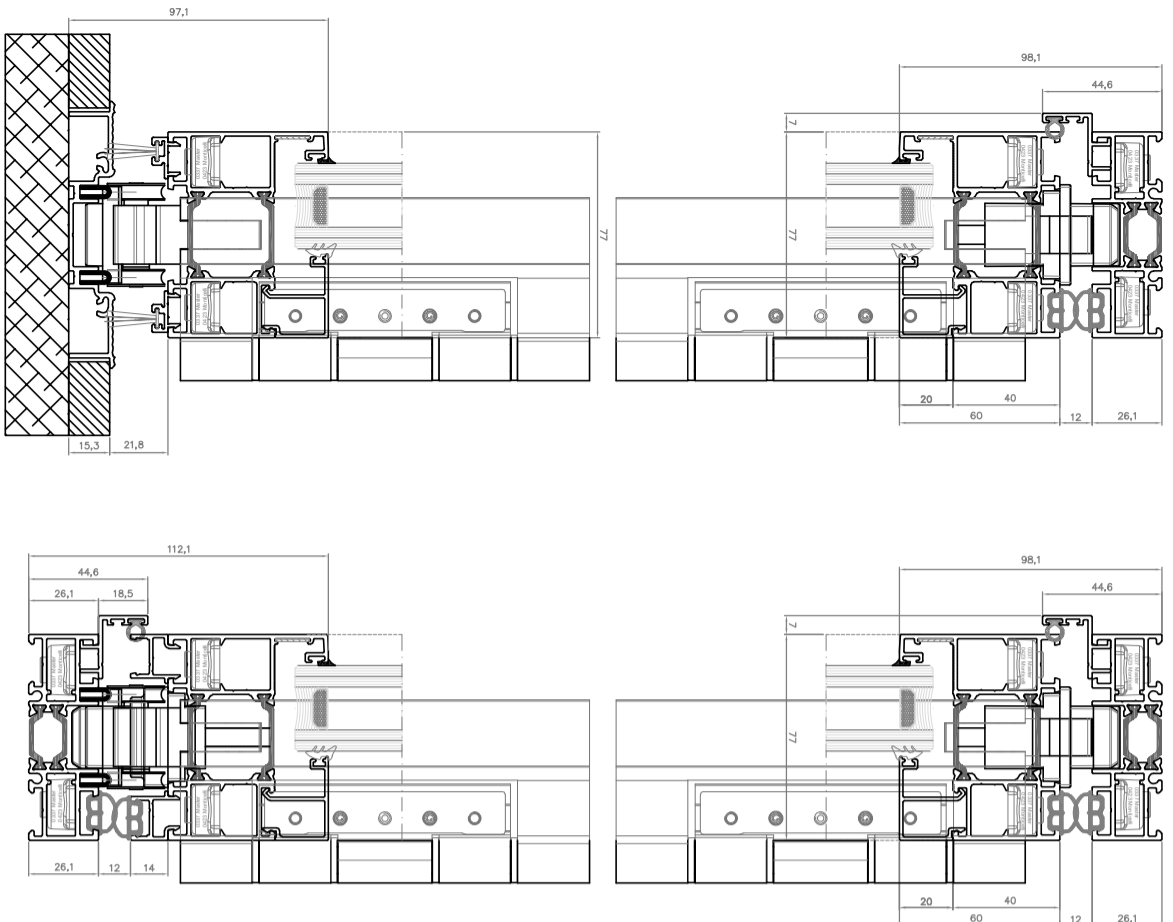

SECCIÓN B-B

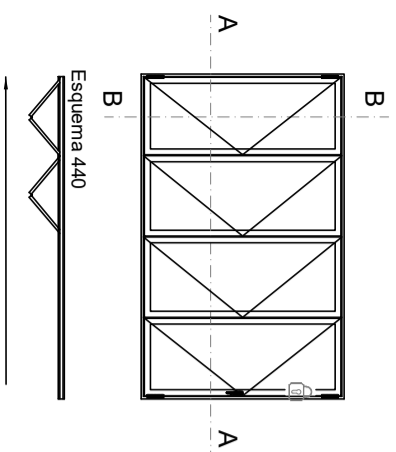

**SECCIÓN A-A  
EN POSICIÓN CERRADA**

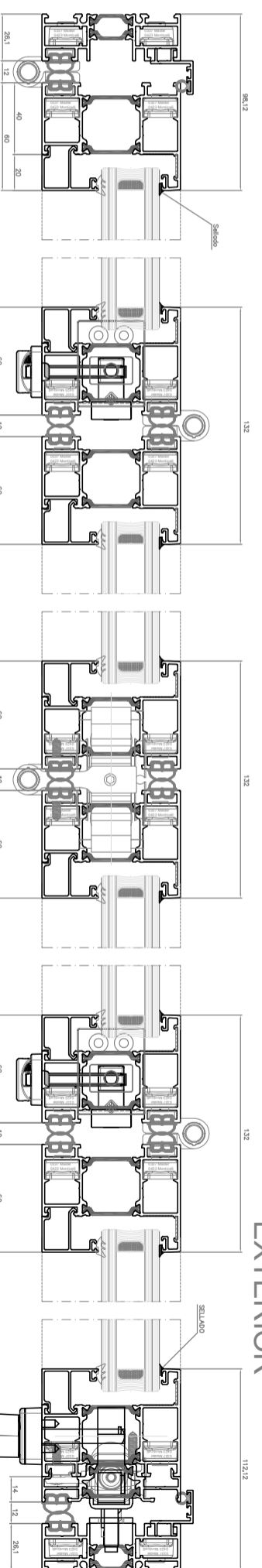

**SECCIÓN A-A  
EN POSICIÓN ABIERTA**

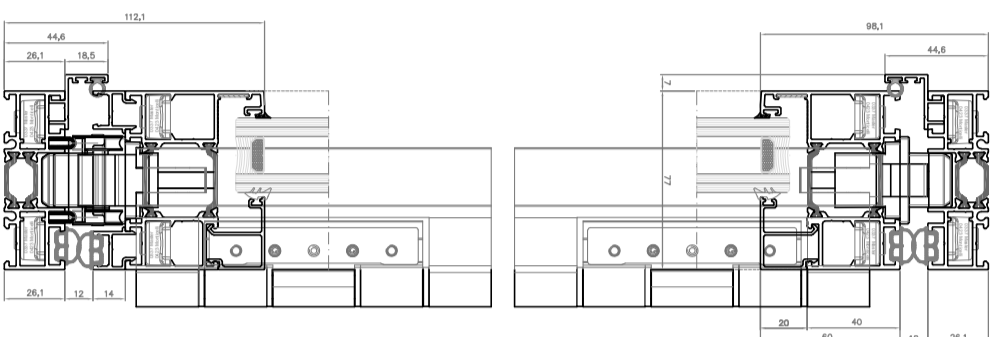
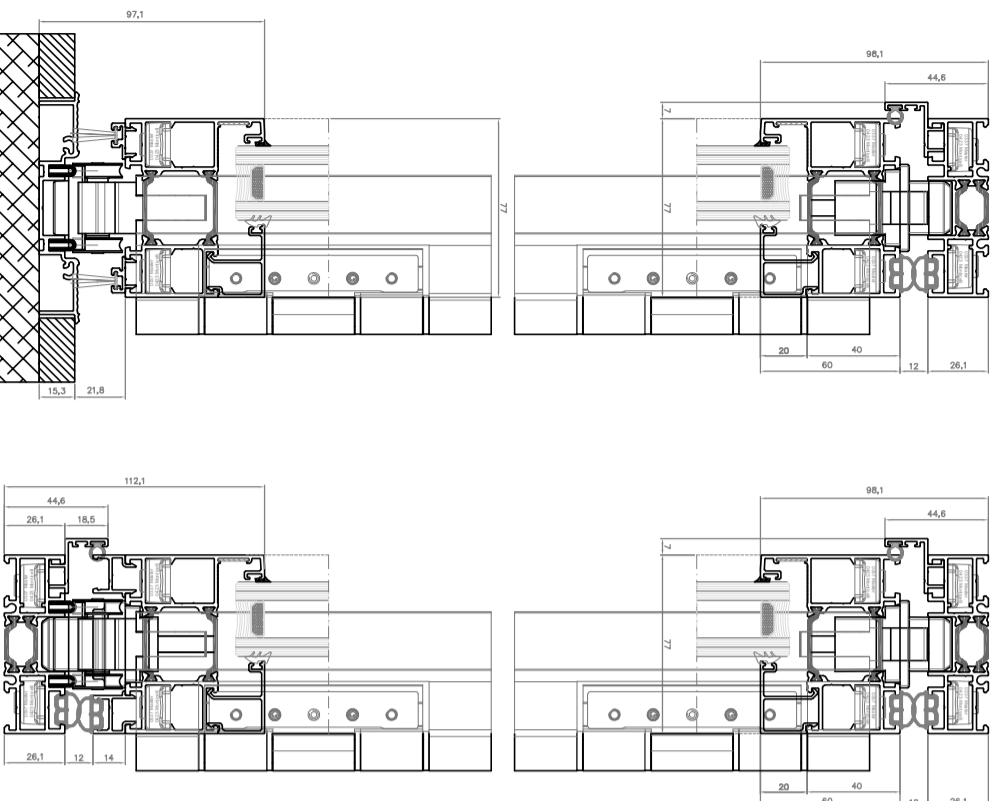
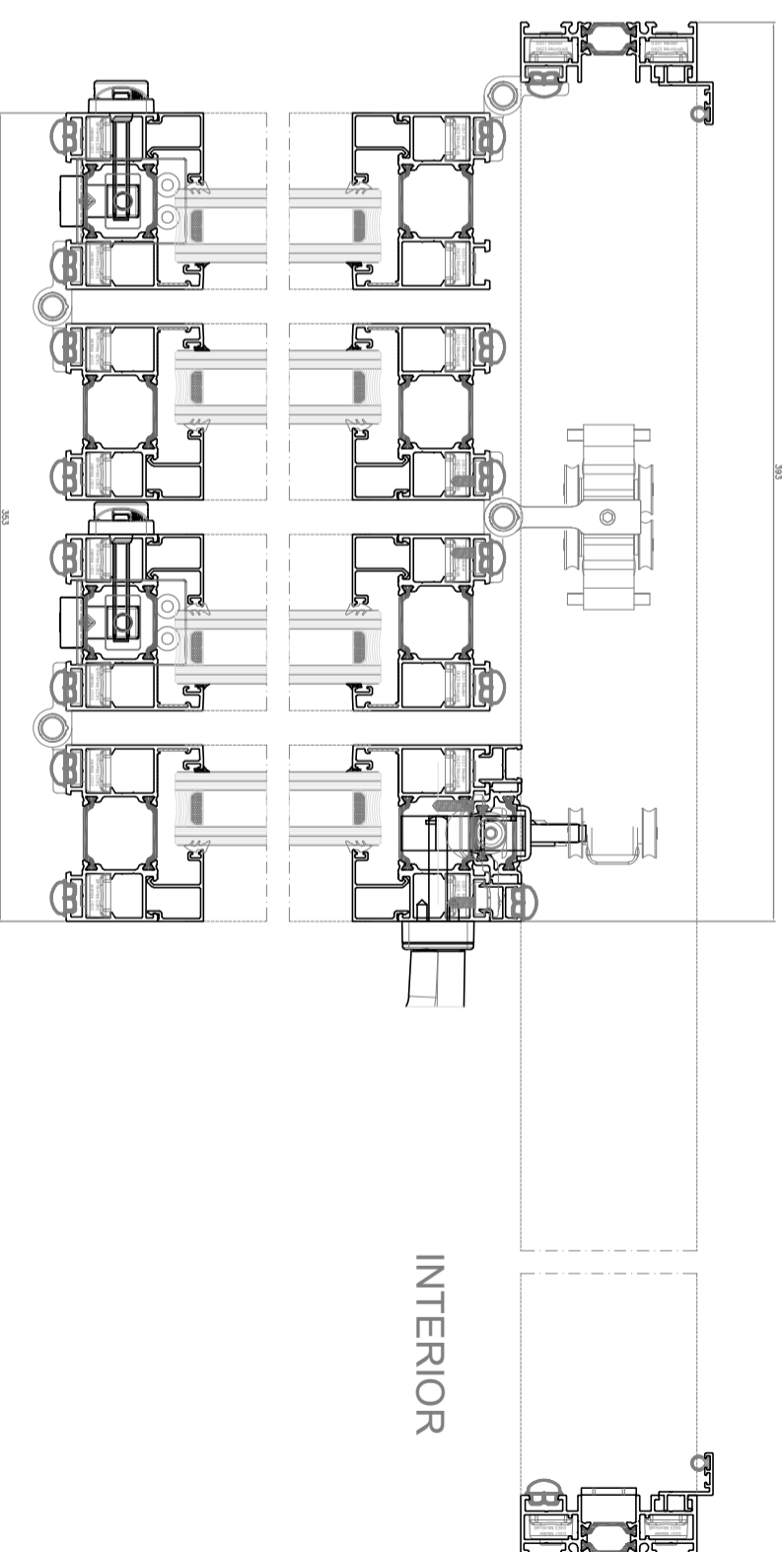

**SECCIÓN B-B**

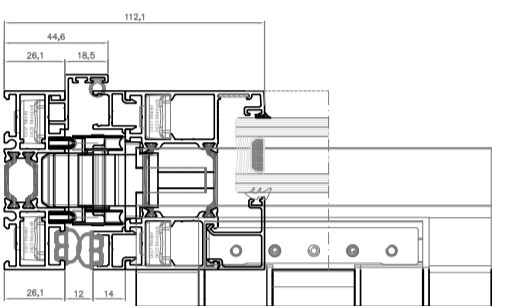
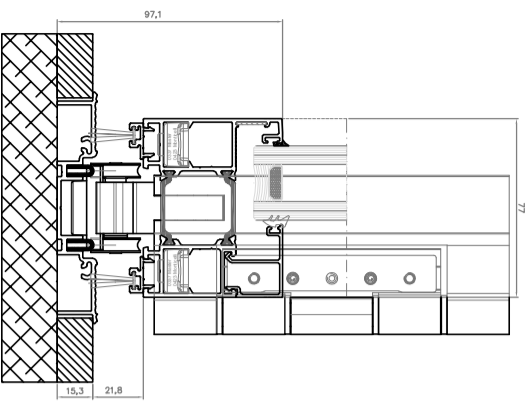

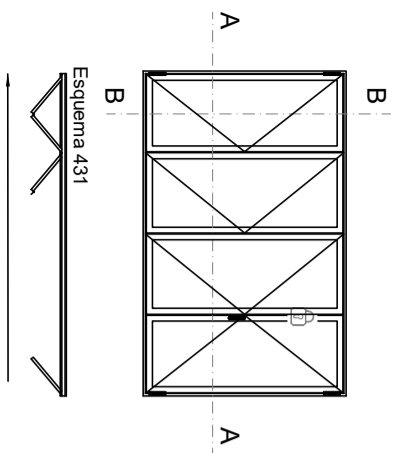

**SECCIÓN A-A  
EN POSICIÓN CERRADA**

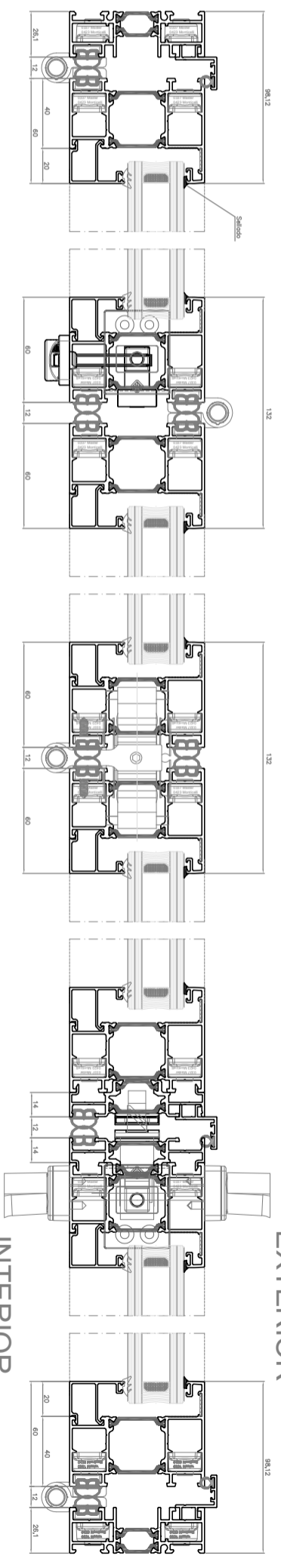

**SECCIÓN A-A  
EN POSICIÓN ABIERTA**

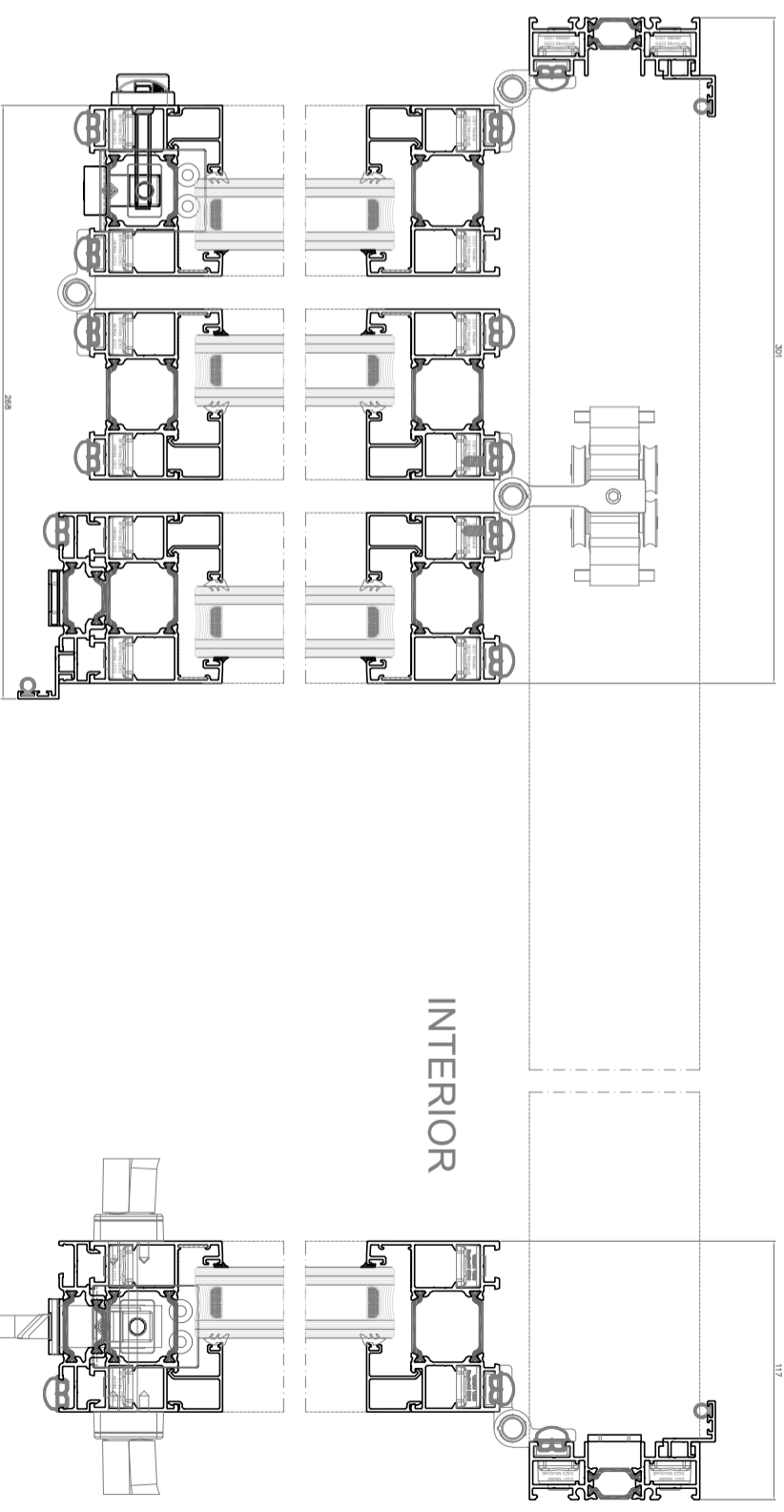

**SECCIÓN B-B**

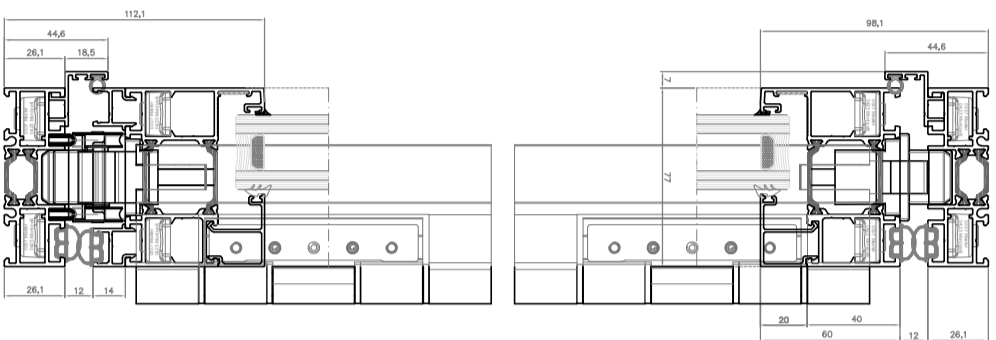
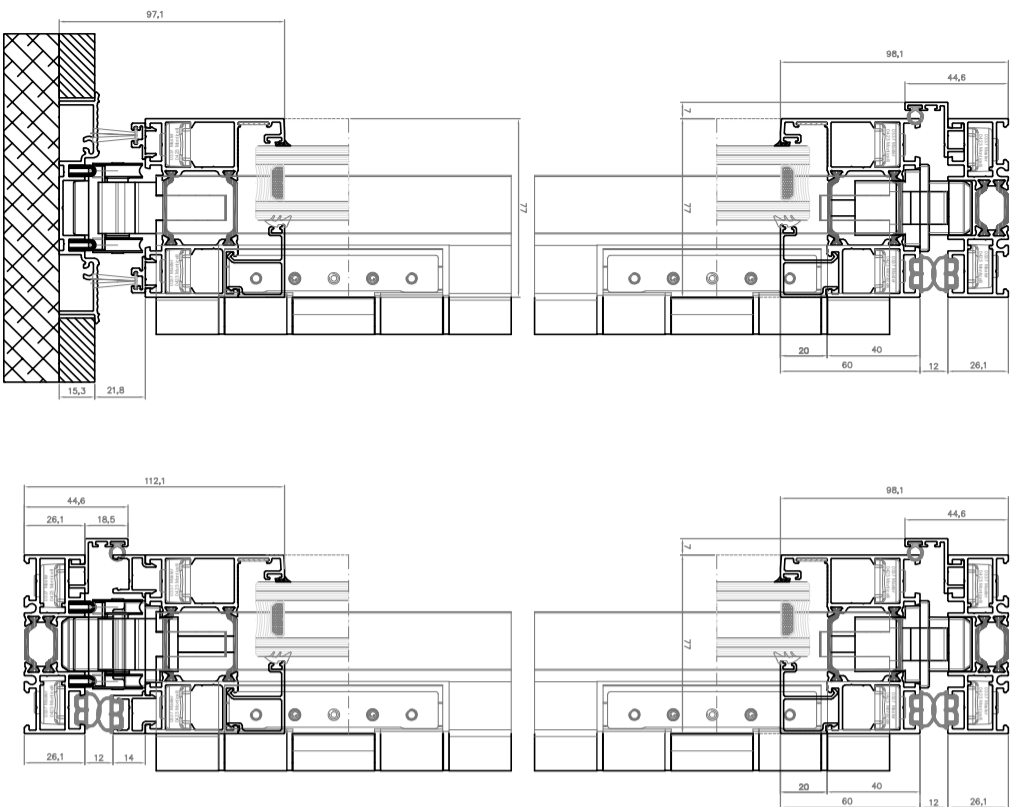

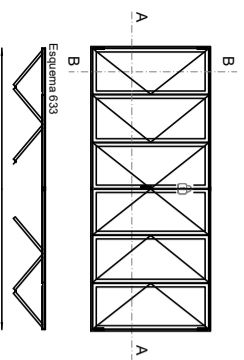

SECCIÓN A-A  
EN POSICIÓN CERRADA

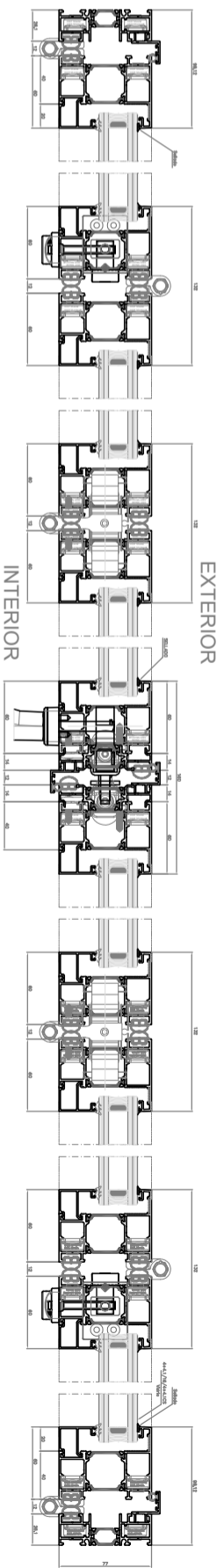

SECCIÓN A-A  
EN POSICIÓN ABIERTA

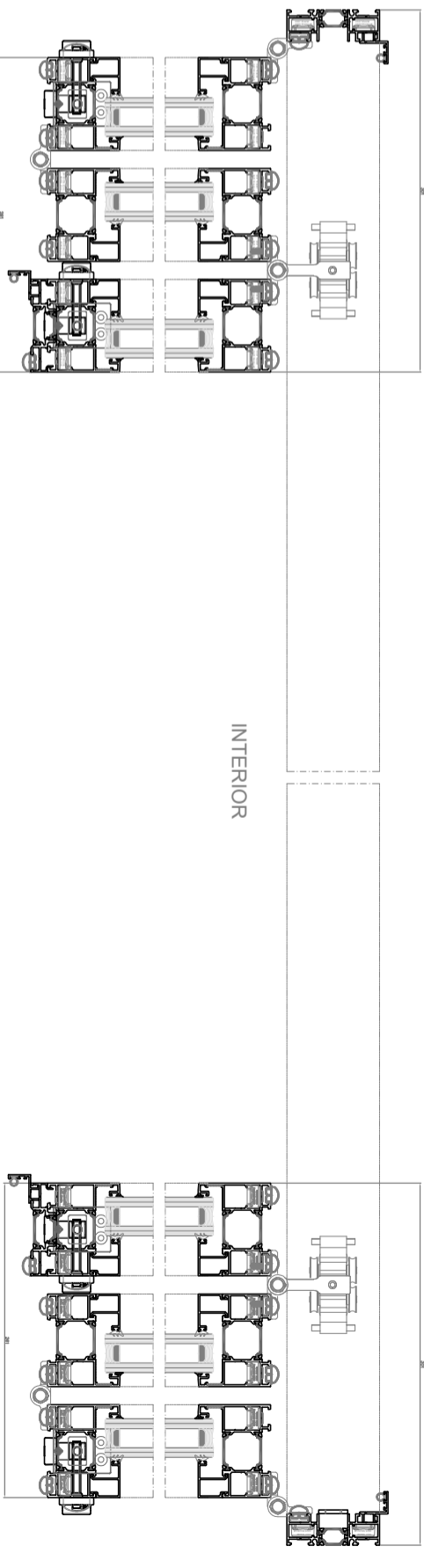

SECCIÓN B-B

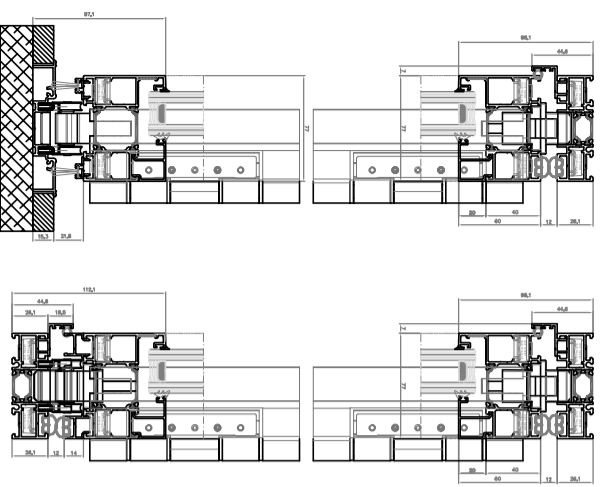



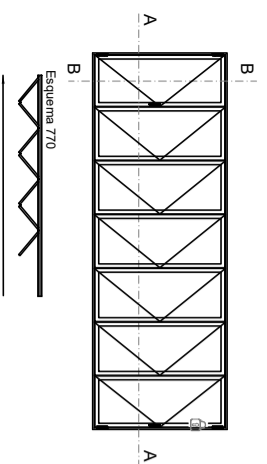

SECCIÓN A-A  
EN POSICIÓN CERRADA

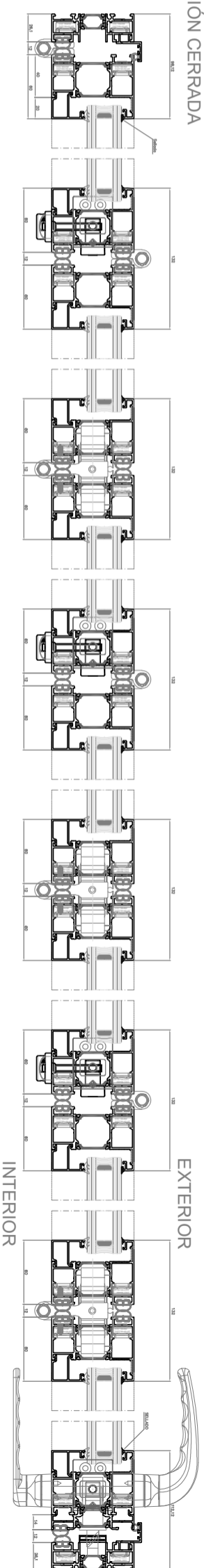

SECCIÓN A-A  
EN POSICIÓN ABIERTA

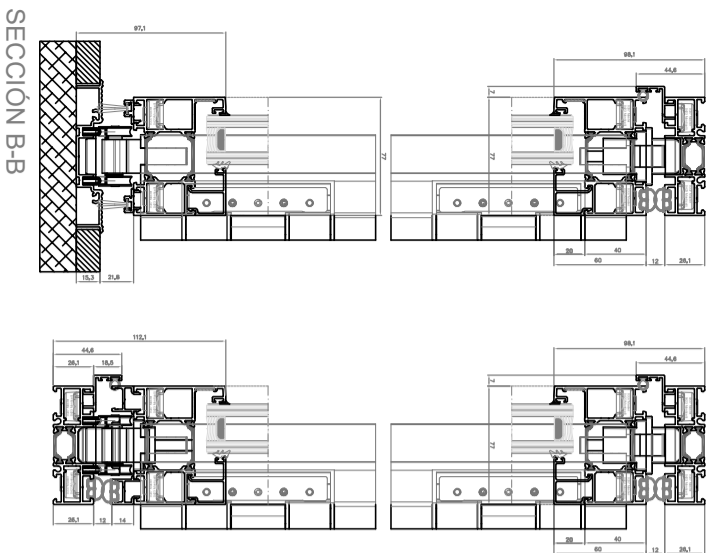
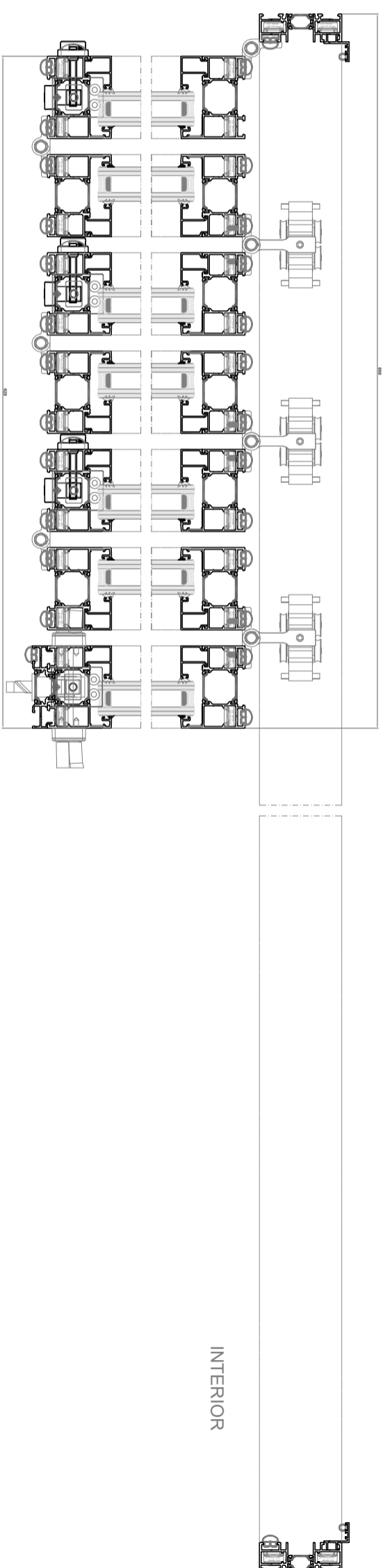

SECCIÓN B-B

	SERIE:	QS-XL	ESCALA:	1:1
	TÍTULO: Secciones Plegables 120 Kg. de 7 hojas. esquema 770		FECHA:	06/05/2022
			DISEÑADOR:	J.M.MARIZ

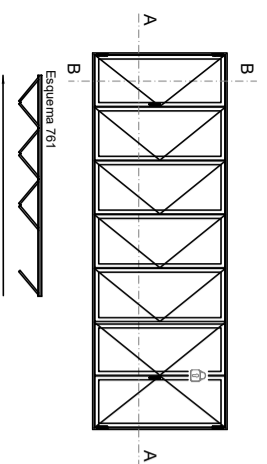

SECCIÓN A-A  
EN POSICIÓN CERRADA

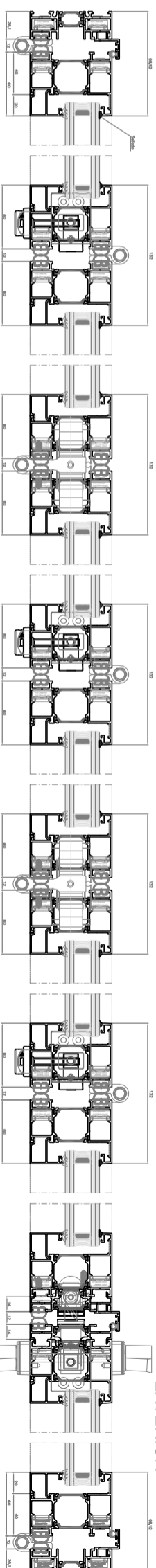

SECCIÓN A-A  
EN POSICIÓN ABIERTA

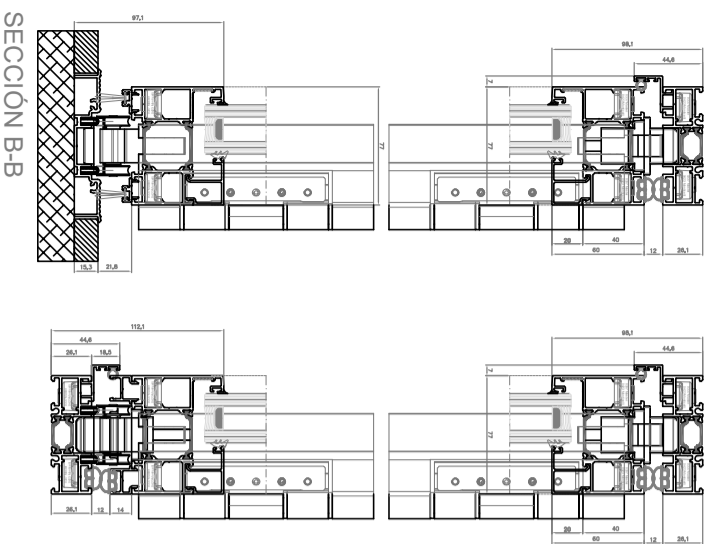
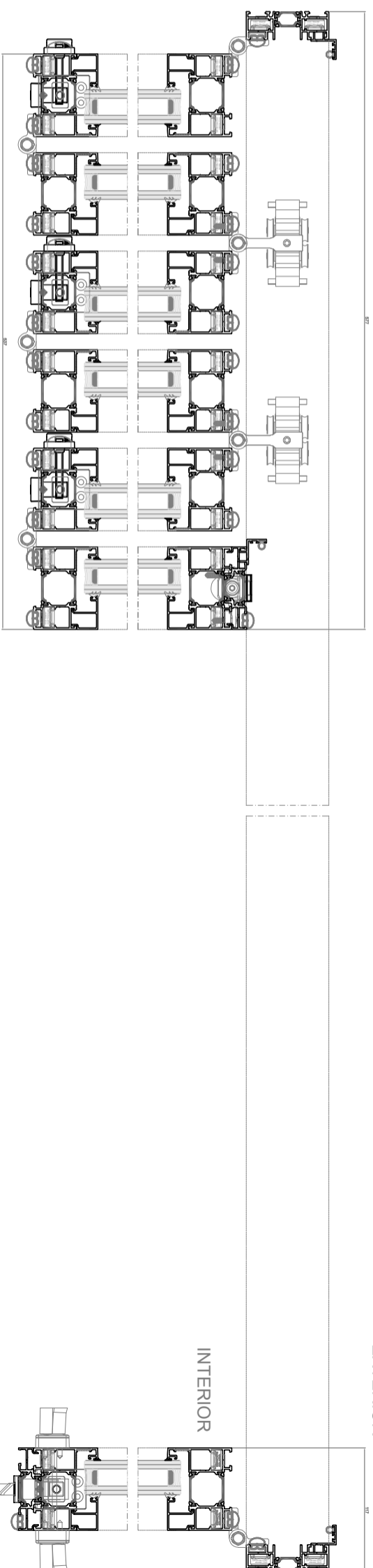

SECCIÓN B-B

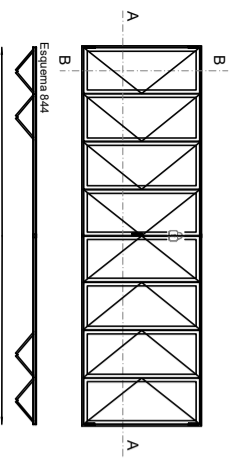

SECCIÓN A-A  
 EN POSICIÓN CERRADA

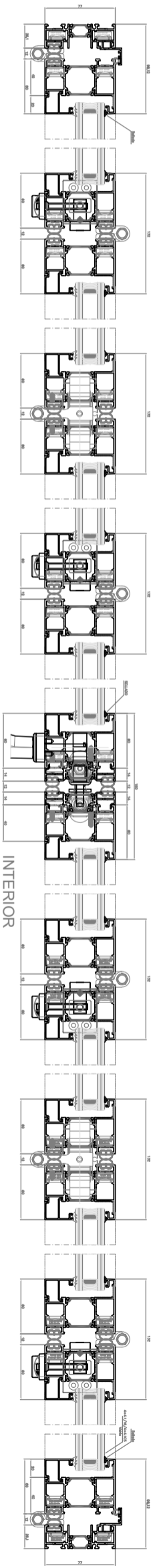

SECCIÓN A-A  
 EN POSICIÓN ABIERTA

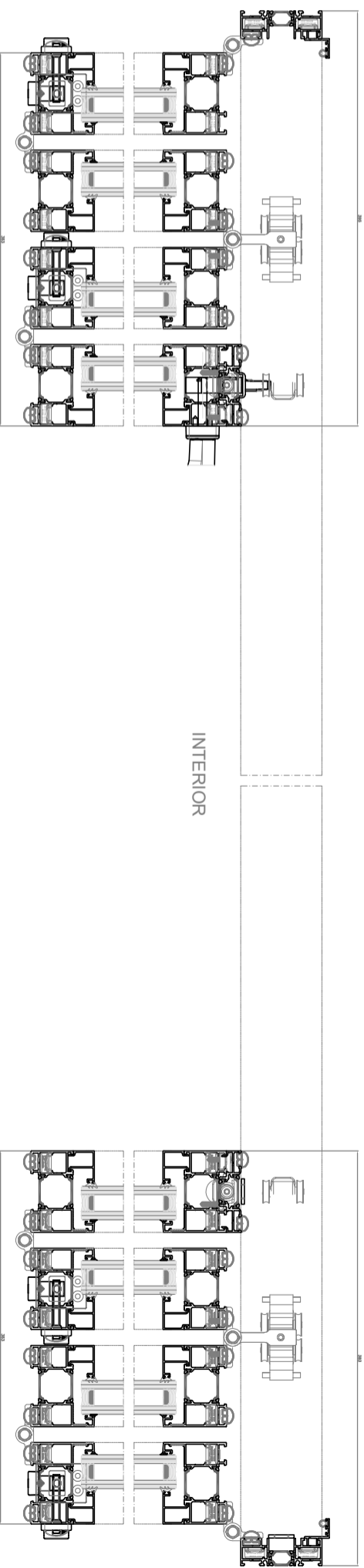

SECCIÓN B-B

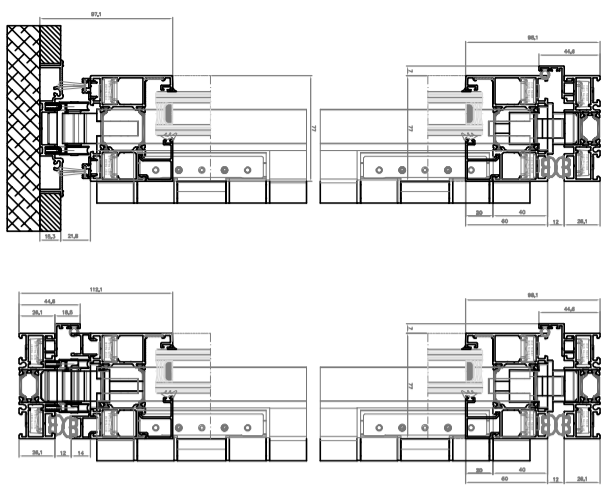

# ACRISTALAMIENTOS

## GLAZING

Tabla de acristalado, sellado exterior

*Glazed table, with external silicone sealing*

Tabla de acristalado, sellado exterior

*Glazed table, with external silicone sealing*



Tabla de acristalado, sellado exterior

*Glazed table, with external silicone sealing*

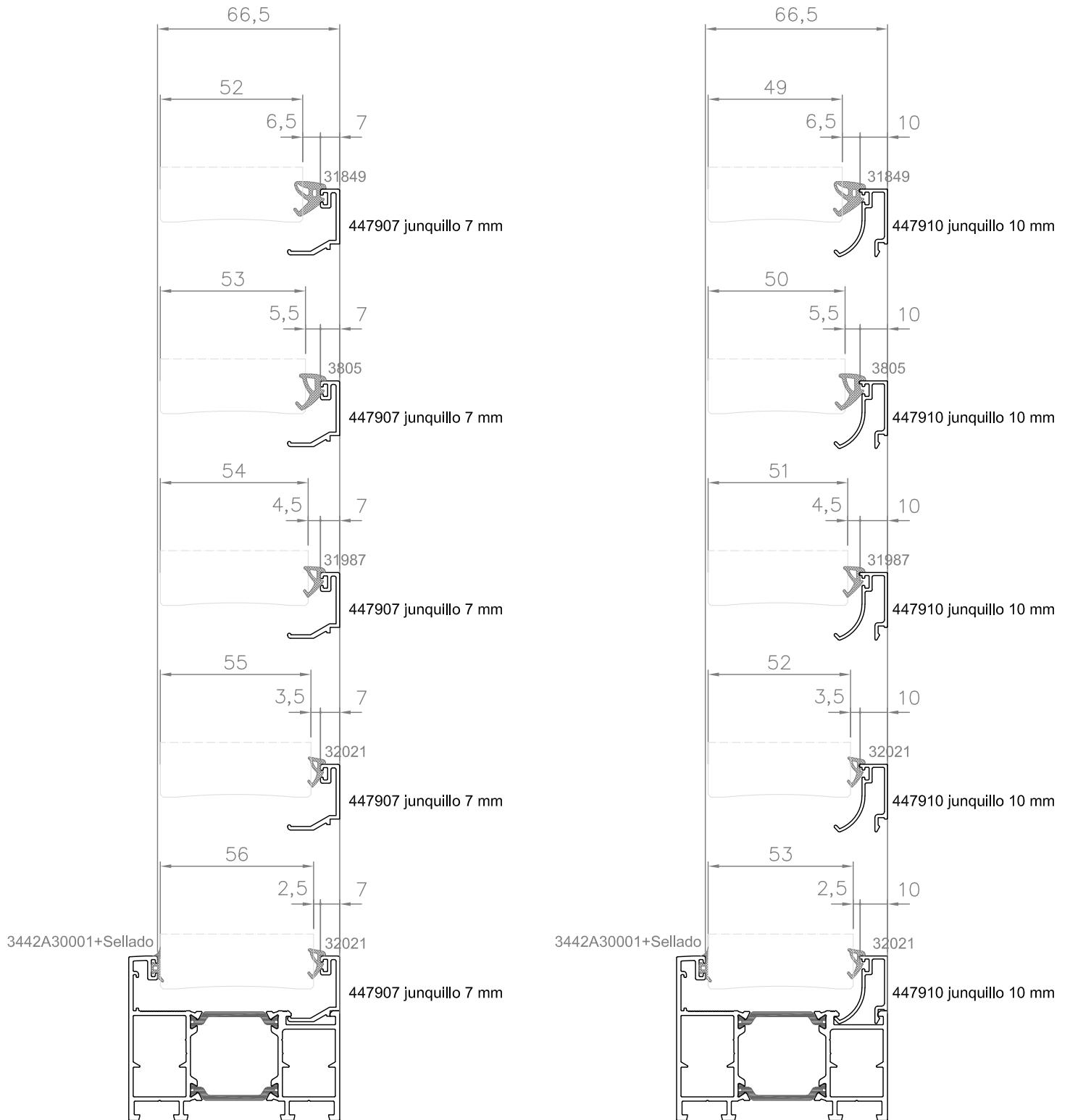

Tabla de acristalado, sellado exterior

*Glazed table, with external silicone sealing*

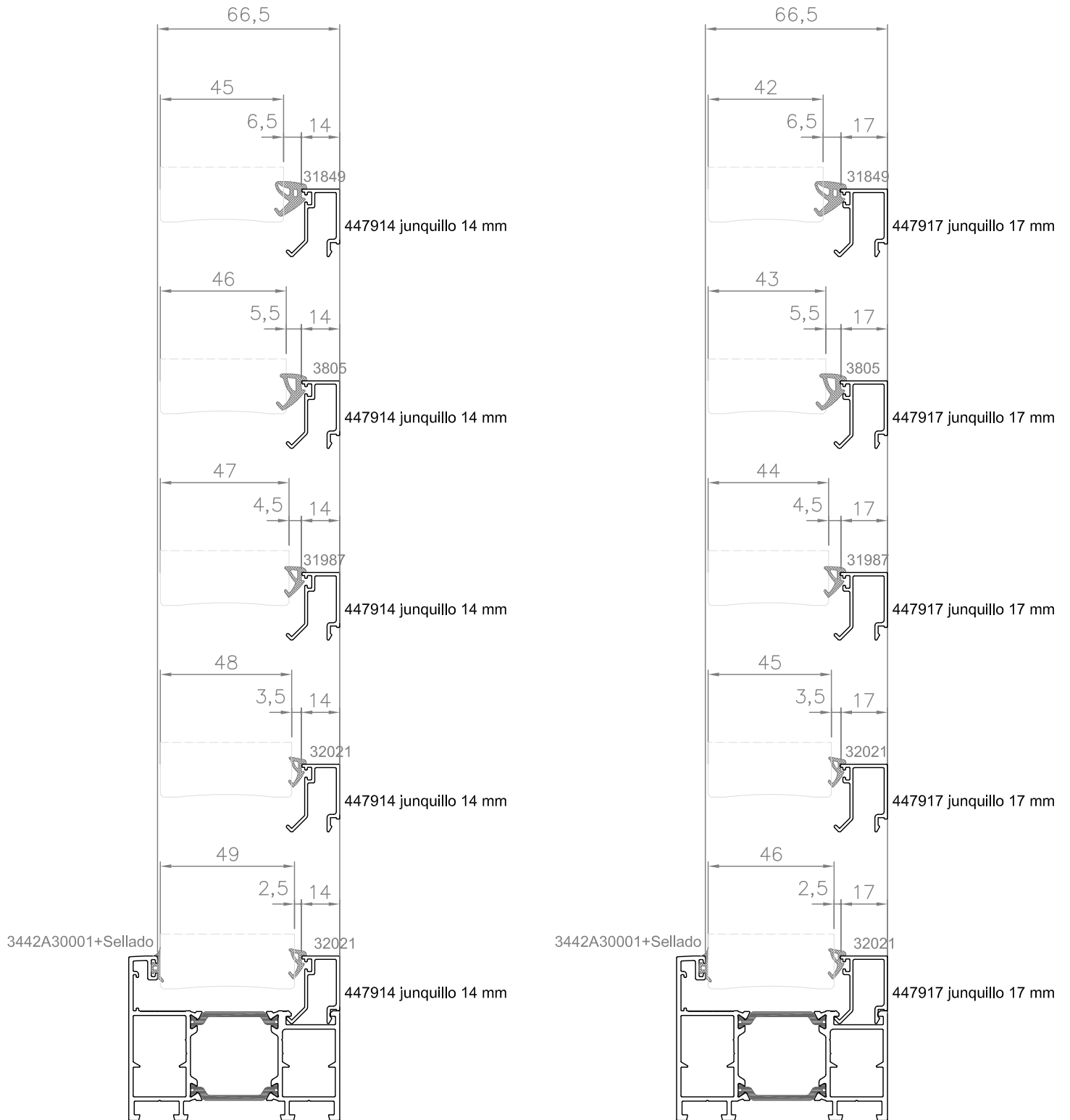

Tabla de acristalado, sellado exterior

*Glazed table, with external silicone sealing*



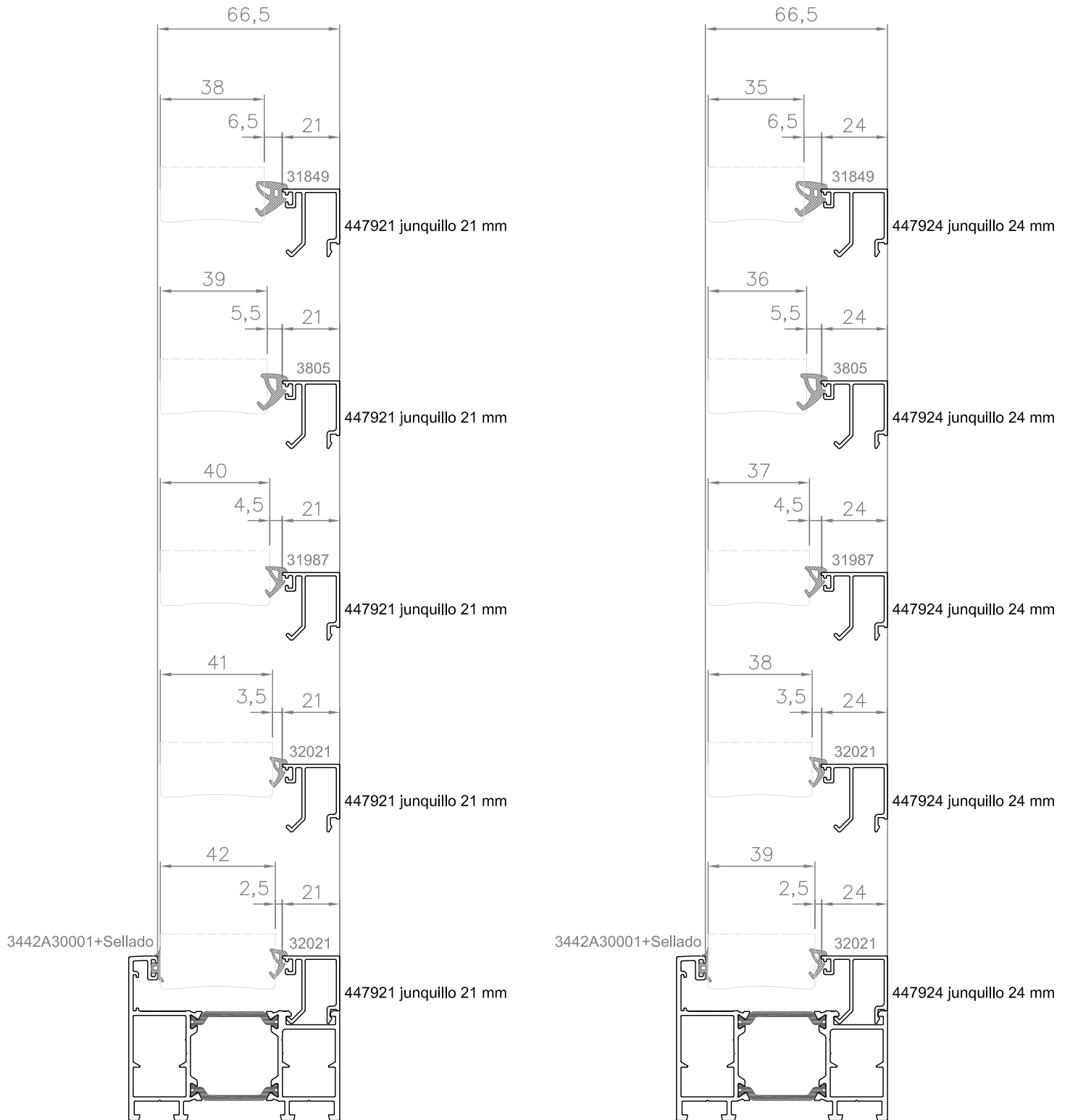

Tabla de acristalado, sellado exterior

*Glazed table, with external silicone sealing*

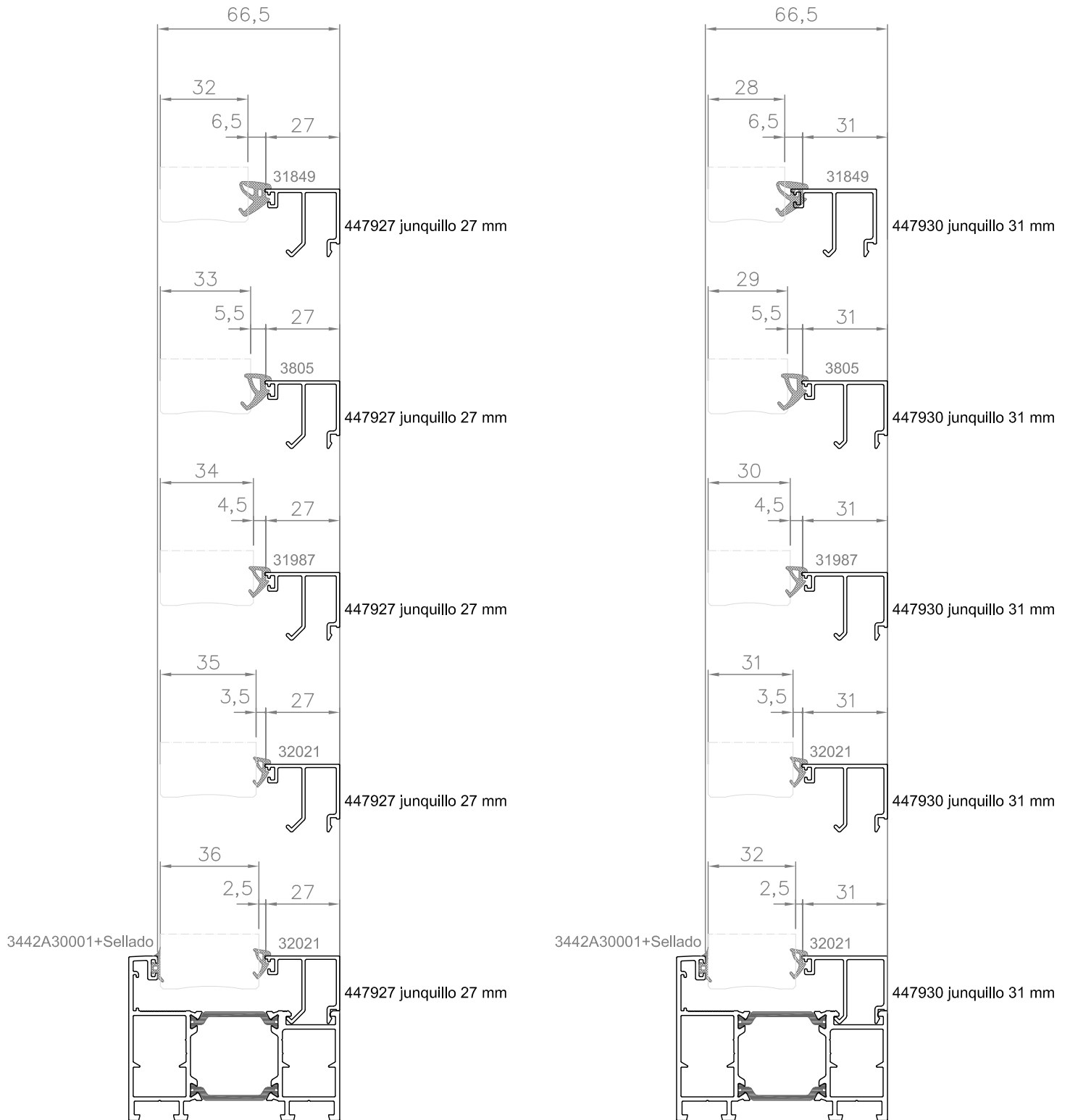

Tabla de acristalado, sellado exterior

*Glazed table, with external silicone sealing*

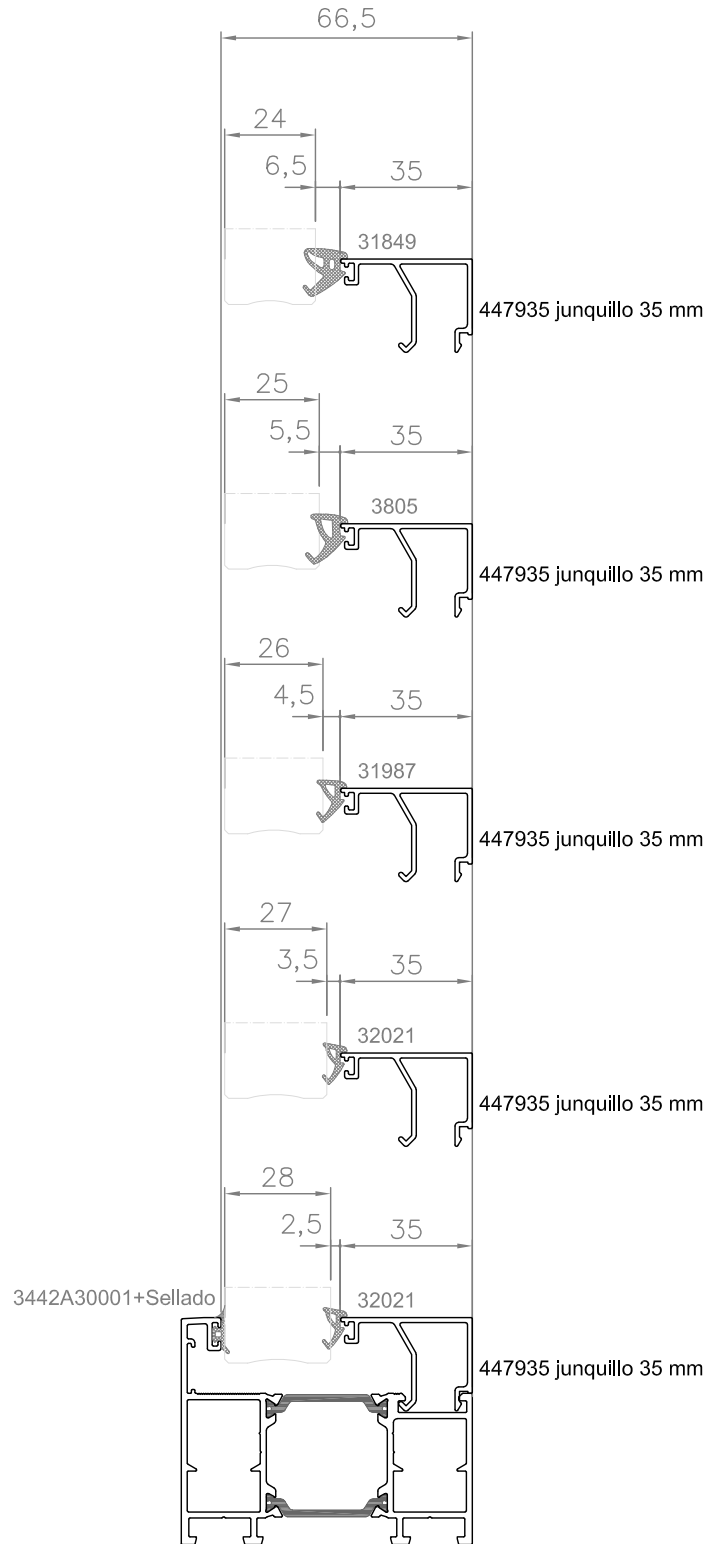
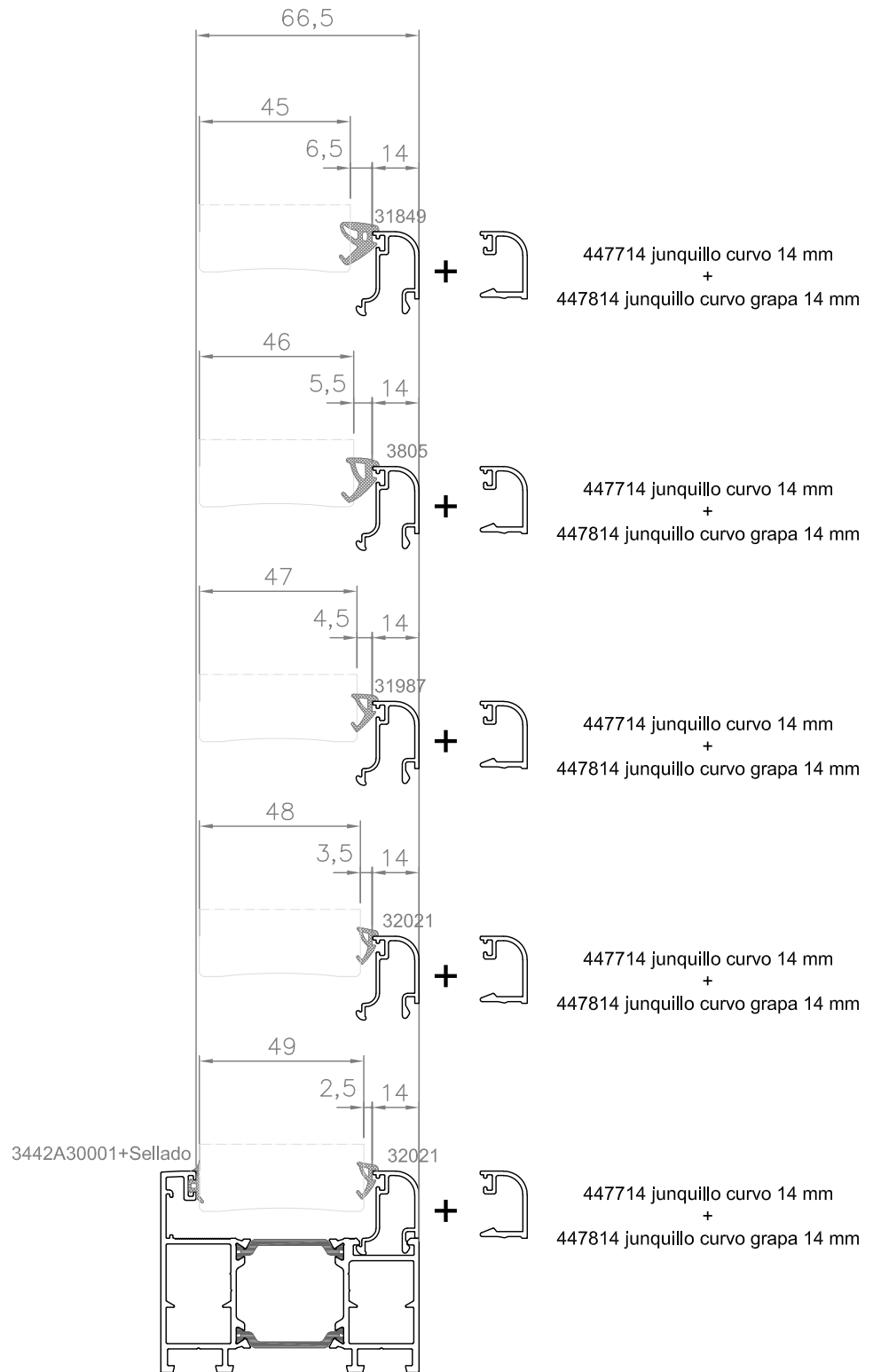

## Tabla de acristalado, sellado exterior

*Glazed table, with external silicone sealing*

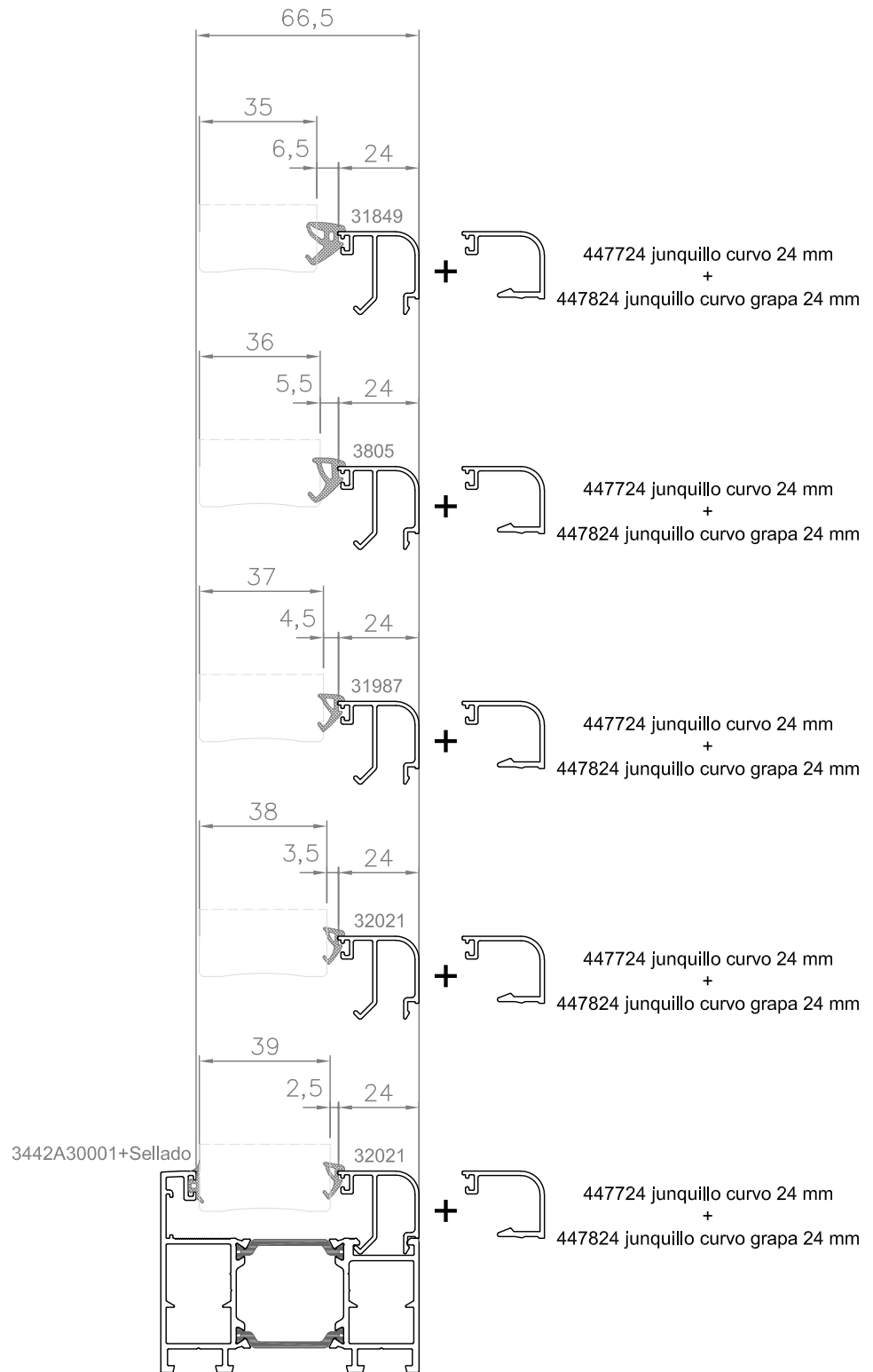

# ACRISTALAMIENTOS

## GLAZING

Tabla de acristalado, engomado exterior

*Glazed table, with outer joint*

**Tabla de acristalado, engomado exterior**  
*Glazed table, with outer joint*

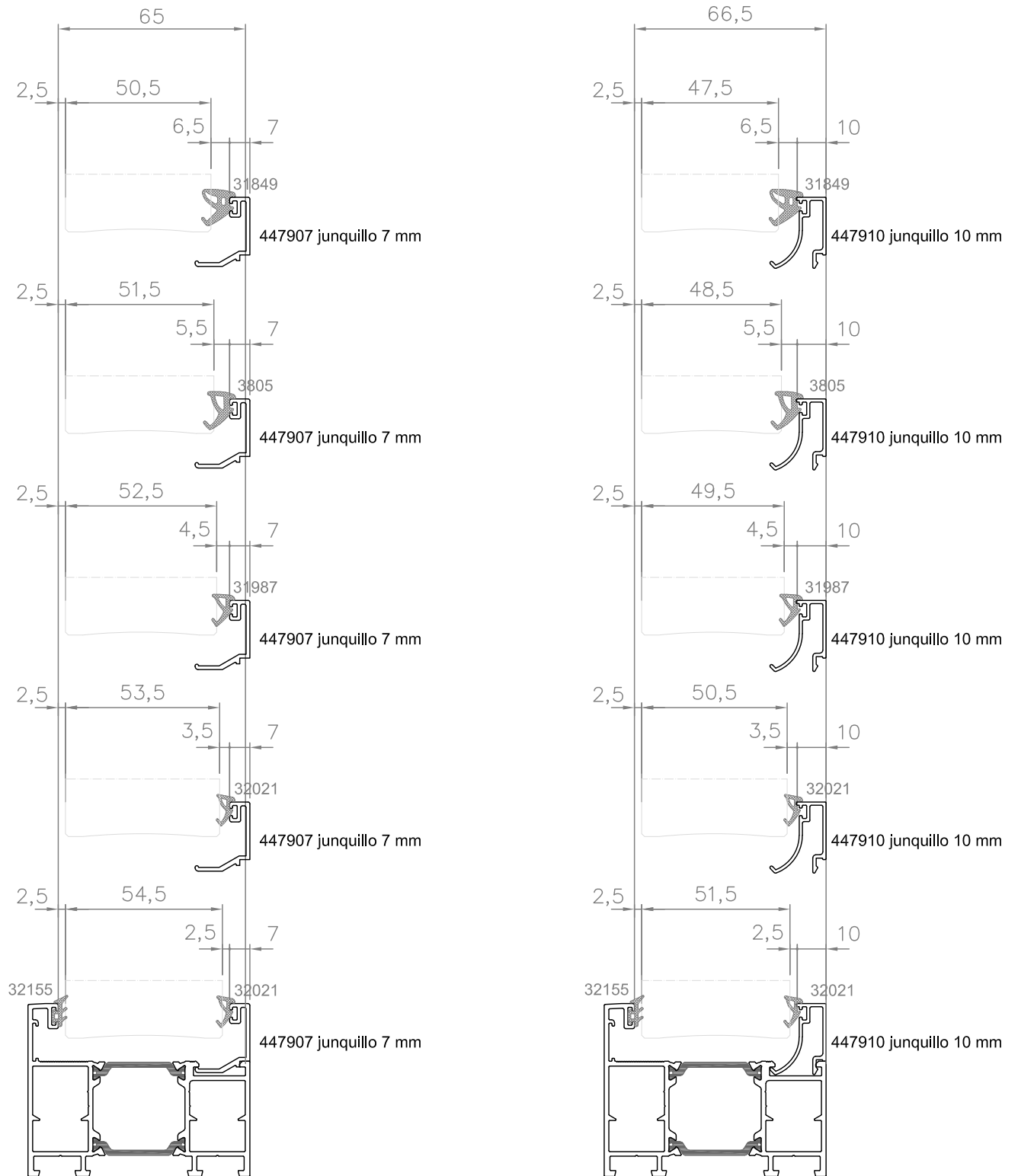

**Tabla de acristalado, engomado exterior**  
*Glazed table, with outer joint*

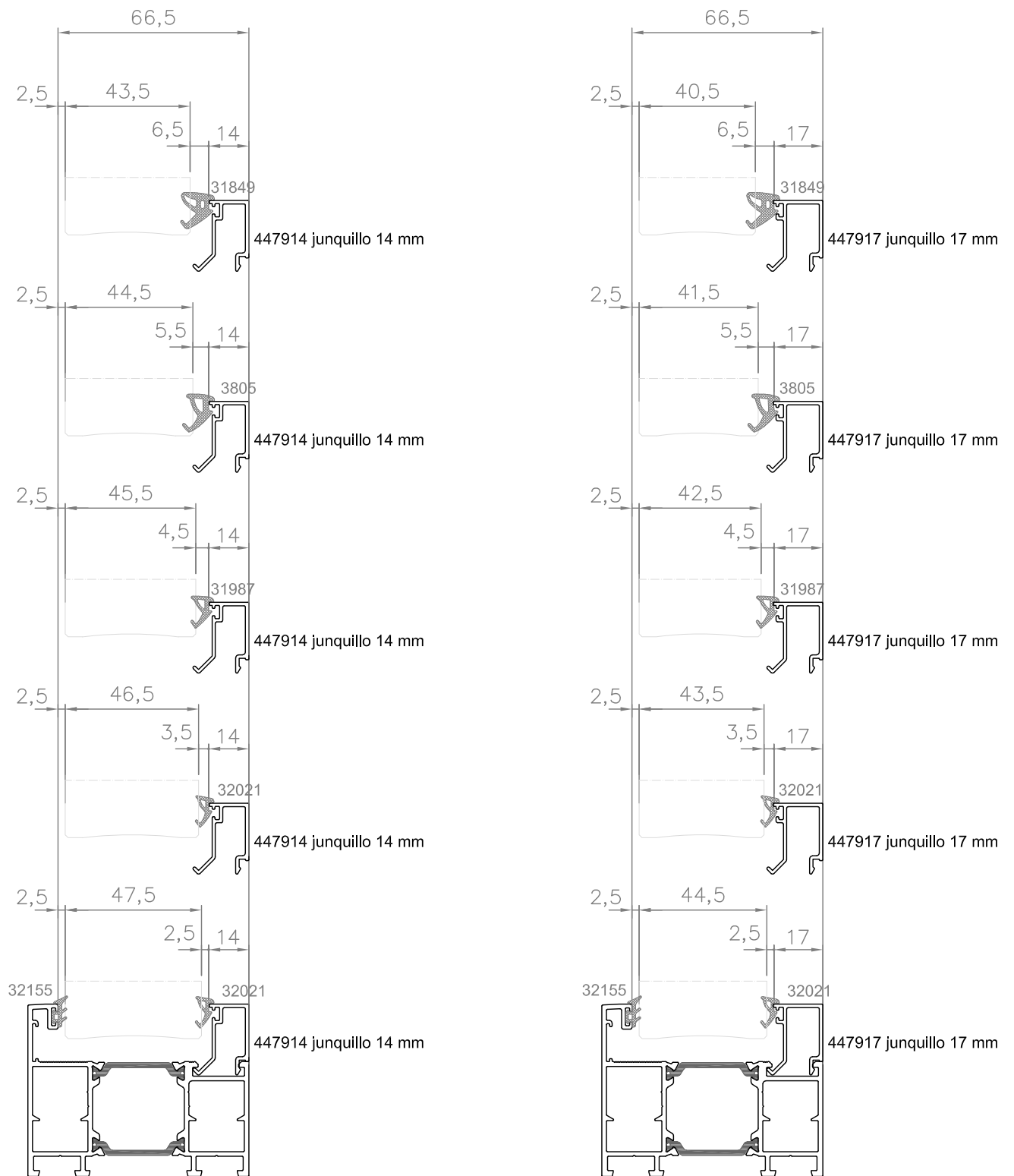

**Tabla de acristalado, engomado exterior**  
*Glazed table, with outer joint*

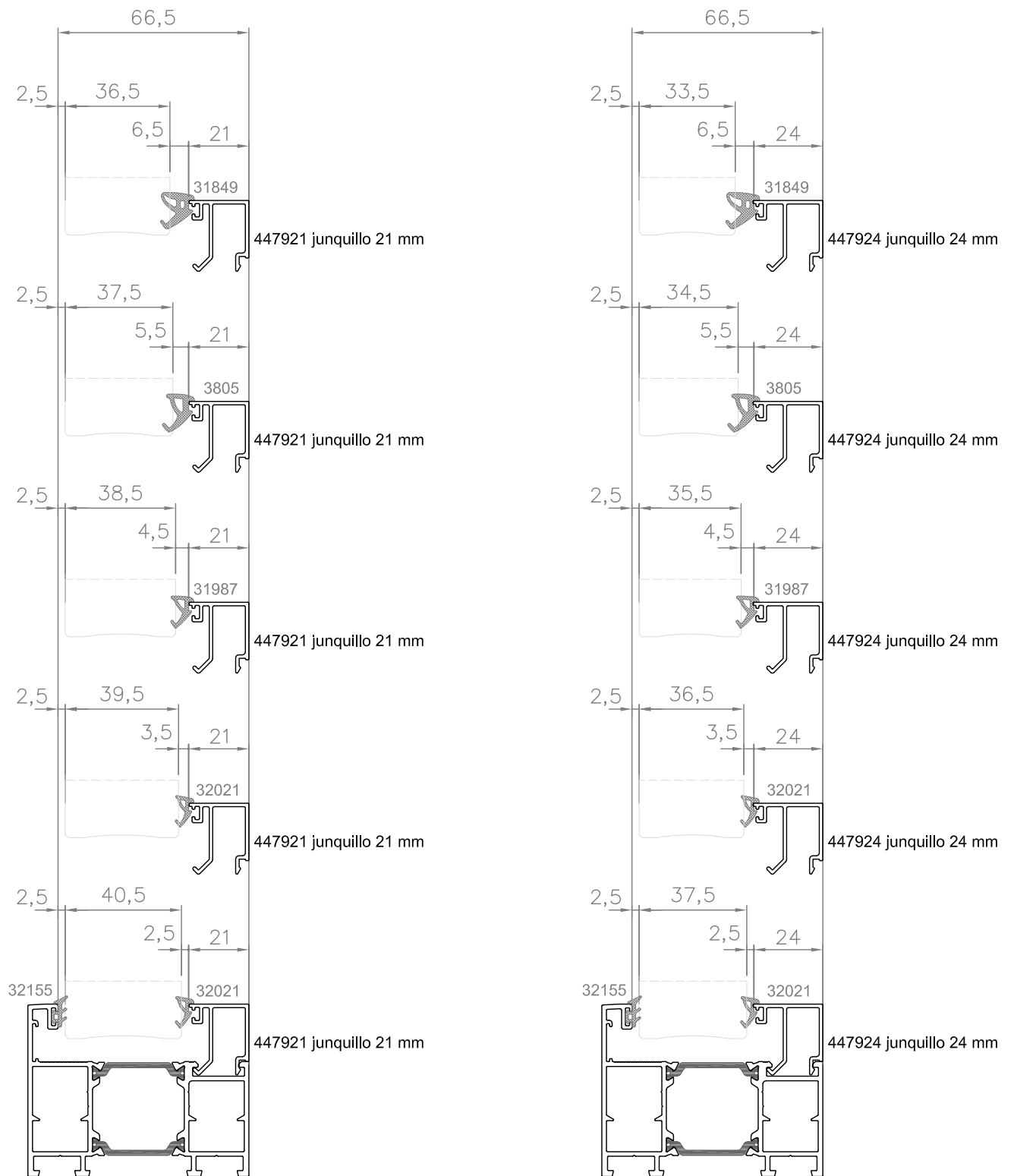

## Tabla de acristalado, engomado exterior

*Glazed table, with outer joint*

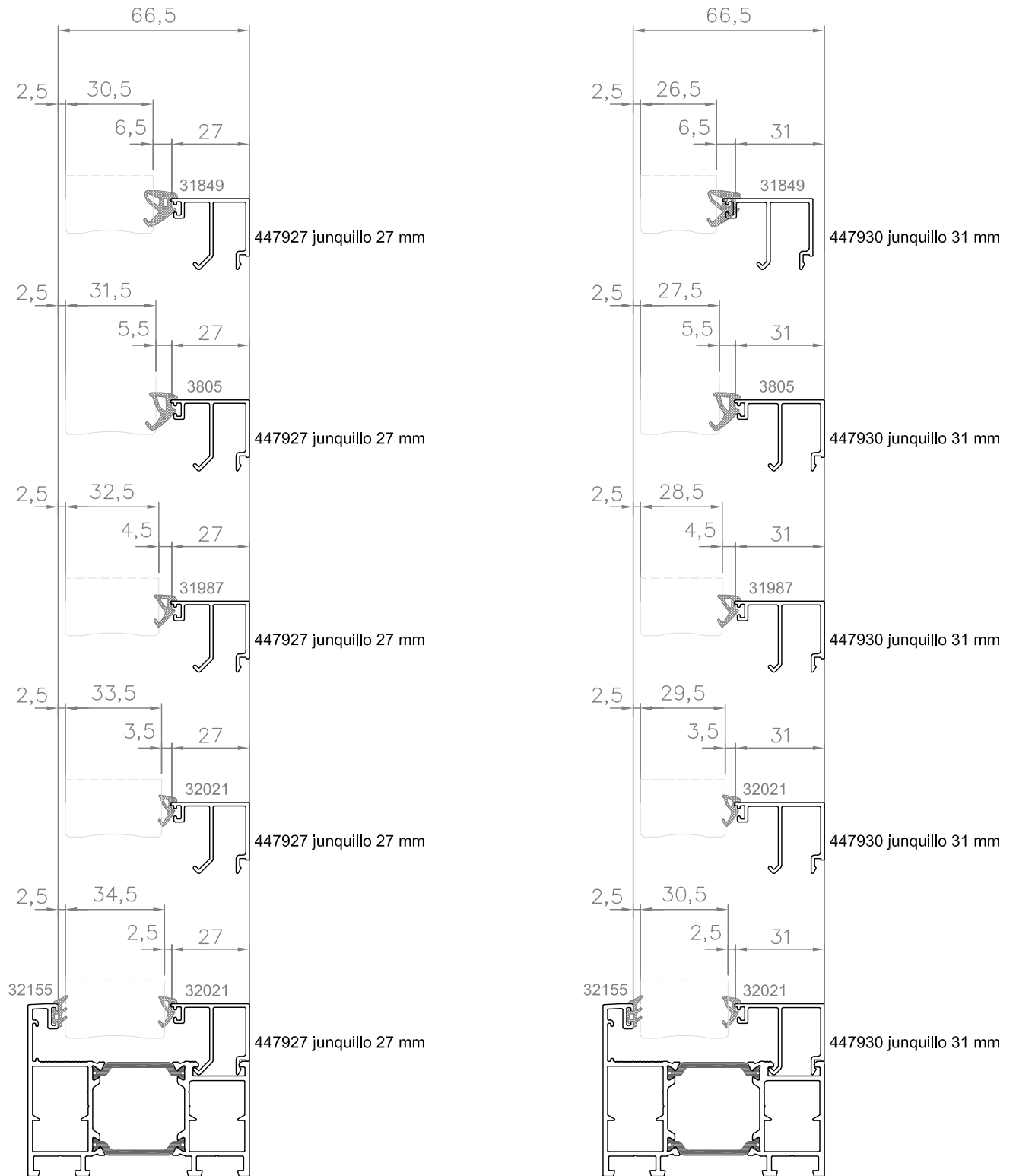



**Tabla de acristalado, engomado exterior**  
*Glazed table, with outer joint*

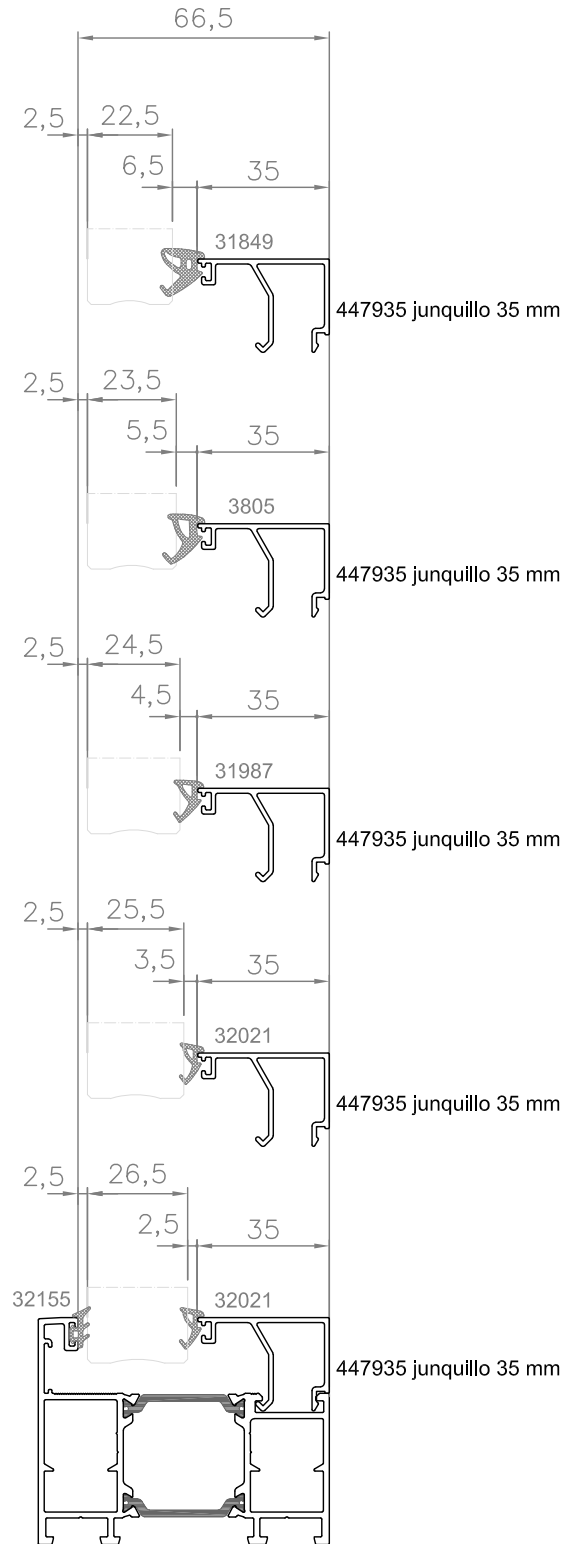

**Tabla de acristalado, engomado exterior**  
*Glazed table, with outer joint*

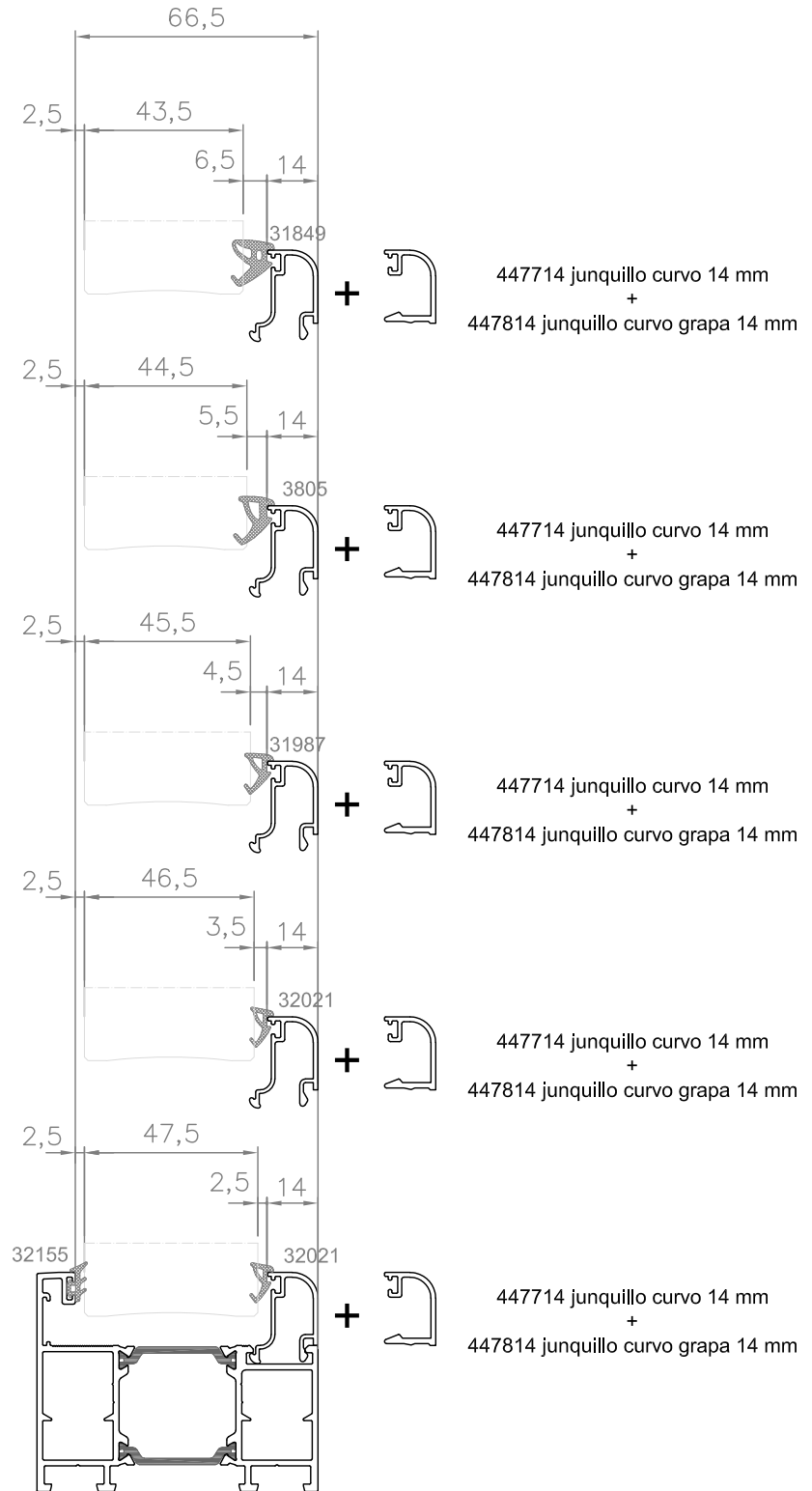

## Tabla de acristalado, engomado exterior

*Glazed table, with outer joint*

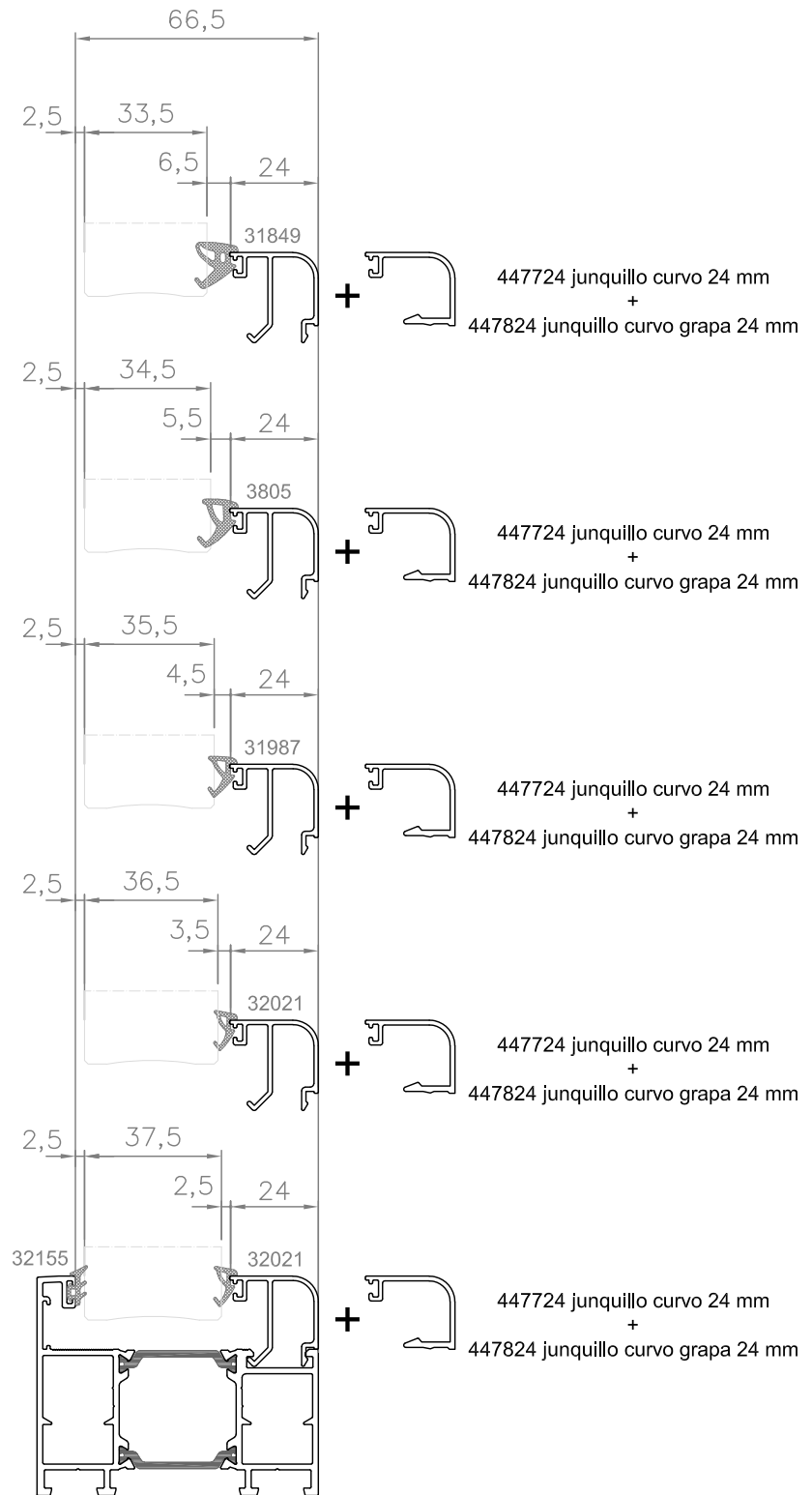

# FÓRMULAS DE CORTE

## *CUT FORMULAS*

# Soluciones

solutions

# QS-XL

- SOLUCION A.....77
  - DOS TRAMOS PARES
  - UN TRAMO PAR
  - SIN TRAMOS PARES
- SOLUCION B.....87
  - DOS TRAMOS PARES
  - UN TRAMO PAR
  - SIN TRAMOS PARES
- SOLUCION C.....97
  - DOS TRAMOS PARES
  - UN TRAMO PAR
  - SIN TRAMOS PARES
- SOLUCION B.....107
  - DOS TRAMOS PARES
  - UN TRAMO PAR
  - SIN TRAMOS PARES
- SOLUCION F.....117
  - DOS TRAMOS PARES
  - UN TRAMO PAR
  - SIN TRAMOS PARES
- SOLUCION G.....127
  - DOS TRAMOS PARES
  - UN TRAMO PAR
  - SIN TRAMOS PARES
- SOLUCION H.....137
  - DOS TRAMOS PARES
  - UN TRAMO PAR
  - SIN TRAMOS PARES

**Sección vertical con marco inferior 79100**  
*Vertical section with bottom frame 79100*

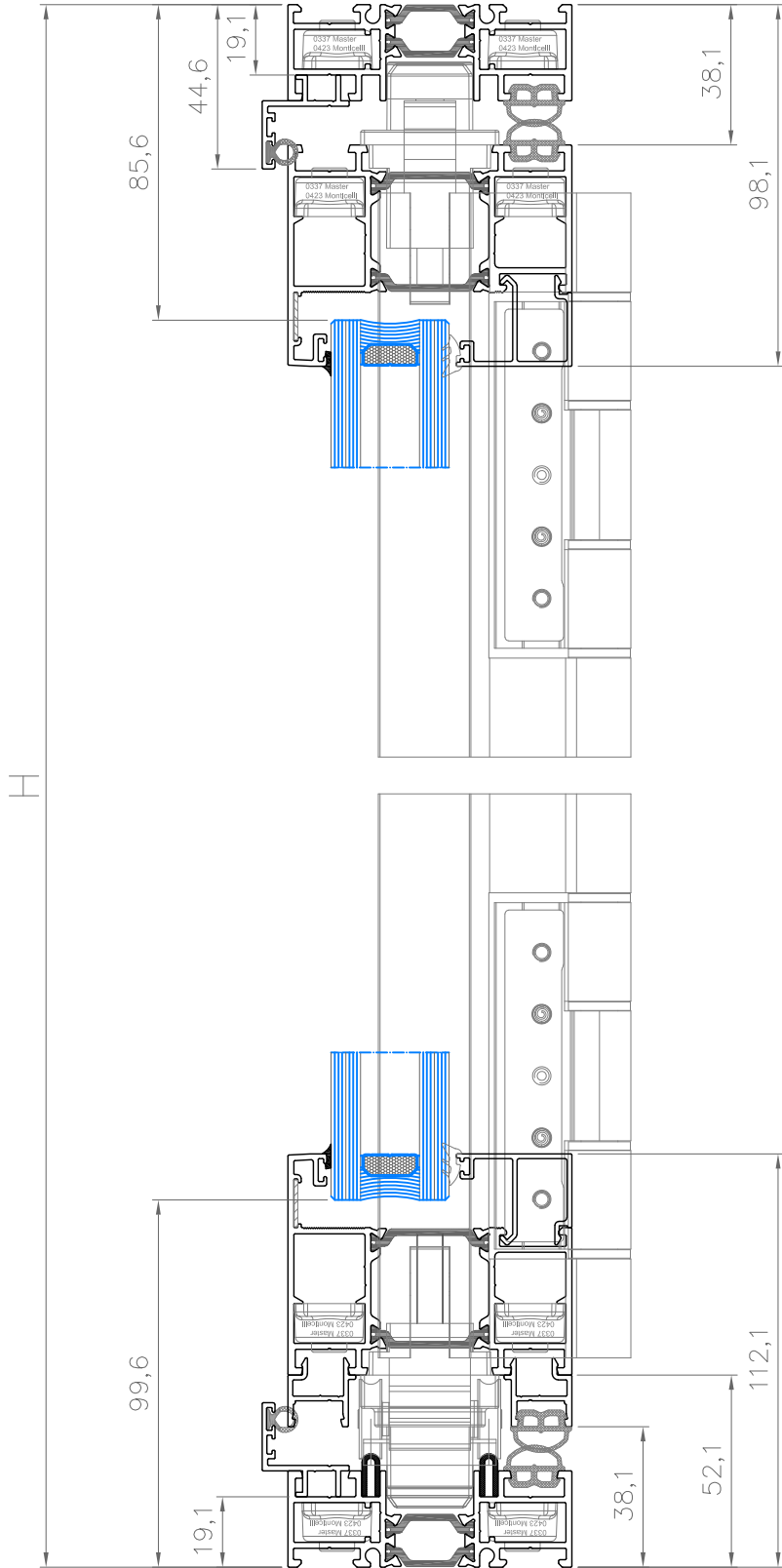

H

**Solución inferior "A"**  
*Lower solution "A"*

## Plegable con MARCO INFERIOR 79100, CIERRE CENTRAL

*Folding with LOWER FRAME 79100, CENTRAL CLOSURE*

Esquemas: 422, 642, 844 y 862

*Scheme: 422, 642, 844 y 862*

Cierre central con 2 perfiles 79102







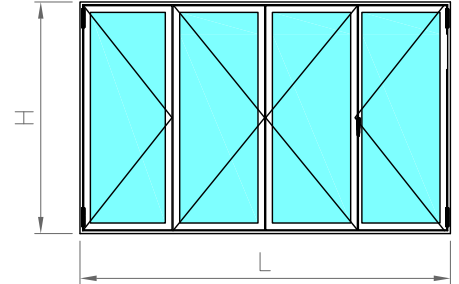













*Central closure with 2 profiles 79102*

N = número de hojas

*N = number of sashes*



## FÓRMULAS DE CORTES | CUT FORMULAS

Perfiles de marco   Frame Profiles					
Sección   Section	Descripción   Description	Referencia   Cod.	Corte   Cut	Medida   Med.	Cantidad   Qty.
	Marco 77 mm <i>Frame 77 mm</i>	79100		L	2
				H	2
	Hoja 77 mm <i>Sash 77 mm</i>	79101		$[L - 80,2 - (N + 1) \times 12 - 102] / N$	$(N-2) \times 2$
				$[[L - 80,2 - (N - 1) \times 12 - 102] / N] + 51$	4
				H - 90,2	N x 2
	Complemento cerradura 77 mm <i>77 mm lock complement profile</i>	79102		H - 76,2	2
	Batiente <i>Profile support</i>	79103		L - 38,2	2
				H - 38,2	2
	Suplemento 14 mm <i>Supplement profile 14 mm</i>	79104		$[L - 80,2 - (N + 1) \times 12 - 102] / N$	$(N-2) \times 2$
				$[[L - 80,2 - (N - 1) \times 12 - 102] / N] + 51$	4
	Junquillo recto <i>Straight glazing</i>	(**)		$[L - 92,2 - (N \times 92) - 102] / N$	$(N-2) \times 2$
				$[[L - 92,2 - (N \times 92) - 102] / N] + 51$	4
				H - 210,2	N x 2

(\*\*) Seleccionar junquillos en página de acristalamientos

*(\*\*) Select straight glazing on the glazing page*

Vidrios   Glasses			
Medidas   Med.			Cantidad   Qty.
Con marco inferior 79100 <i>With bottom frame 79100</i>	$[L - 306,2 - (N - 2) \times 107 - 102] / N$	H - 185	N - 2
	$[[L - 306,2 - (N - 2) \times 107 - 102] / N] + 51$		2

## Plegable con MARCO INFERIOR 79100, CIERRE CENTRAL

*Folding with LOWER FRAME 79100, CENTRAL CLOSURE*

Esquemas: 422, 642, 844 y 862

*Scheme: 422, 642, 844 y 862*

Cierre central con 1 perfiles 79102







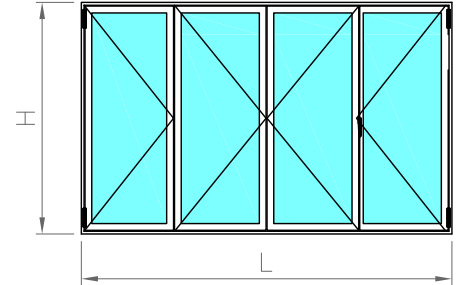















*Central closure with 1 profiles 79102*

N = número de hojas

*N = number of sashes*



## FÓRMULAS DE CORTES | CUT FORMULAS

Perfiles de marco   Frame Profiles					
Sección   Section	Descripción   Description	Referencia   Cod.	Corte   Cut	Medida   Med.	Cantidad   Qty.
	Marco 77 mm <i>Frame 77 mm</i>	79100		L	2
				H	2
	Hoja 77 mm <i>Sash 77 mm</i>	79101		$[L - 66,2 - (N + 1) \times 12 - 102] / N$	(N-2) x 2
				$[[L - 66,2 - (N - 1) \times 12 - 102] / N] + 51$	4
	Complemento cerradura 77 mm <i>77 mm lock complement profile</i>	79102		H - 90,2	N x 2
	Batie <i>Profile support</i>	79103		H - 76,2	1
				L - 38,2	2
	Suplemento 14 mm <i>Supplement profile 14 mm</i>	79104		H - 38,2	2
				L - 38,2	2
	Junquillo recto <i>Straight glazing</i>	(**)		$[L - 66,2 - (N + 1) \times 12 - 102] / N$	(N-2) x 2
				$[[L - 66,2 - (N - 1) \times 12 - 102] / N] + 51$	4
	Junquillo recto <i>Straight glazing</i>	(**)		$[L - 78,2 - (N \times 92) - 102] / N$	(N-2) x 2
				$[[L - 78,2 - (N \times 92) - 102] / N] + 51$	4
	Junquillo recto <i>Straight glazing</i>	(**)		H - 210,2	N x 2

(\*\*) Seleccionar junquillos en página de acristalamientos

*(\*\*) Select straight glazing on the glazing page*

Vidrios   Glasses			
Medidas   Med.			Cantidad   Qty.
Con marco inferior 79100 <i>With bottom frame 79100</i>	$[L - 292 - (N - 2) \times 107 - 102] / N$	H - 185	N - 2
	$[[L - 292 - (N - 2) \times 107 - 102] / N] + 51$		2



Plegable con MARCO INFERIOR 79100, CIERRE CENTRAL

Folding with LOWER FRAME 79100, CENTRAL CLOSURE

Esquemas: 422, 642, 844 y 862

Scheme: 422, 642, 844 y 862

Cierre central sin perfiles 79102







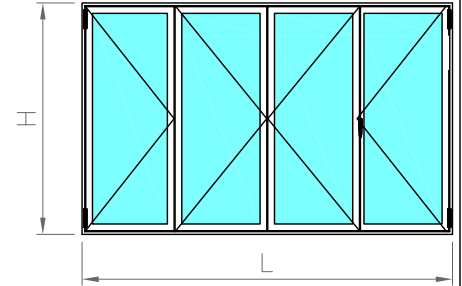









Central closure without profiles 79102

N = número de hojas

N = number of sashes



FÓRMULAS DE CORTES | CUT FORMULAS

Perfiles de marco   Frame Profiles					
Sección   Section	Descripción   Description	Referencia   Cod.	Corte   Cut	Medida   Med.	Cantidad   Qty.
	Marco 77 mm <i>Frame 77 mm</i>	79100		L	2
				H	2
	Hoja 77 mm <i>Sash 77 mm</i>	79101		$[L - 52,2 - (N + 1) \times 12 - 102] / N$	$(N-2) \times 2$
				$[[L - 52,2 - (N + 1) \times 12 - 102] / N] + 51$	4
				H - 90,2	N x 2
	Batie <i>Profile support</i>	79103		L - 38,2	2
				H - 38,2	2
	Suplemento 14 mm <i>Supplement profile 14 mm</i>	79104		$[L - 52,2 - (N + 1) \times 12 - 102] / N$	$(N-2) \times 2$
				$[[L - 52,2 - (N - 1) \times 12 - 102] / N] + 51$	4
	Junquillo recto <i>Straight glazing</i>	(**)		$[L - 64,2 - (N \times 92) - 102] / N$	$(N-2) \times 2$
				$[[L - 64,2 - (N \times 92) - 102] / N] + 51$	4
				H - 210,2	N x 2

(\*\*) Seleccionar junquillos en página de acristalamientos

(\*\*) Select straight glazing on the glazing page

Vidrios   Glasses			
Medidas   Med.			Cantidad   Qty.
Con marco inferior 79100 <i>With bottom frame 79100</i>	$[L - 171,2 - (N - 1) \times 107 - 102] / N$	H - 185	N - 2
	$[[L - 171,2 - (N - 1) \times 107 - 102] / N] + 51$		2

## Plegable con MARCO INFERIOR 79100, CIERRE CENTRAL

*Folding with LOWER FRAME 79100, CENTRAL CLOSURE*

Esquemas: 321, 541, 532, 761, 752 y 743

*Scheme: 321, 541, 532, 761, 752 y 743*

Cierre central con 2 perfiles 79102







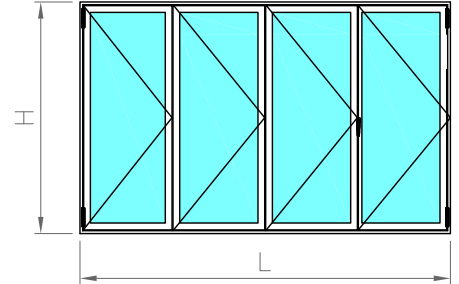













*Central closure with 2 profiles 79102*

N = número de hojas

*N = number of sashes*



## FÓRMULAS DE CORTES | CUT FORMULAS

Perfiles de marco   Frame Profiles					
Sección   Section	Descripción   Description	Referencia   Cod.	Corte   Cut	Medida   Med.	Cantidad   Qty.
	Marco 77 mm <i>Frame 77 mm</i>	79100		L	2
				H	2
	Hoja 77 mm <i>Sash 77 mm</i>	79101		$[L - 80,2 - (N + 1) \times 12 - 51] / N$	$(N-1) \times 2$
				$[[L - 80,2 - (N + 1) \times 12 - 51] + 51] / N$	2
	Batiente <i>Profile support</i>	79103		H - 90,2	N x 2
				H - 76,2	2
				H - 90	1
	Suplemento 14 mm <i>Supplement profile 14 mm</i>	79104		L - 38,2	2
				H - 38,2	2
	Junquillo recto <i>Straight glazing</i>	(**)		H - 90	1
				$[L - 80,2 - (N + 1) \times 12 - 51] / N$	$(N-1) \times 2$
				$[[L - 80,2 - (N + 1) \times 12 - 51] + 51] / N$	2
	Junquillo recto <i>Straight glazing</i>	(**)		$[L - 92,2 - (N \times 92) - 51] / N$	$(N-1) \times 2$
				$[[L - 92,2 - (N \times 92) - 51] / N] + 51$	2
				H - 210,2	N x 2

(\*\*) Seleccionar junquillos en página de acristalamientos

(\*\*) Select straight glazing on the glazing page

Vidrios   Glasses			
Medidas   Med.			Cantidad   Qty.
Con marco inferior 79100 <i>With bottom frame 79100</i>	$[L - 306,2 - (N - 2) \times 107 - 51] / N$	H - 185	N - 1
	$[[L - 306,2 - (N - 2) \times 107 - 51] / N] + 51$		1

Plegable con MARCO INFERIOR 79100, CIERRE CENTRAL

Folding with LOWER FRAME 79100, CENTRAL CLOSURE

Esquemas: 220, 321, 440, 541, 532, 660, 761, 752, 743, 880 y 853

Scheme: 220, 321, 440, 541, 532, 660, 761, 752, 743, 880 and 853

Cierre central con 1 perfiles 79102







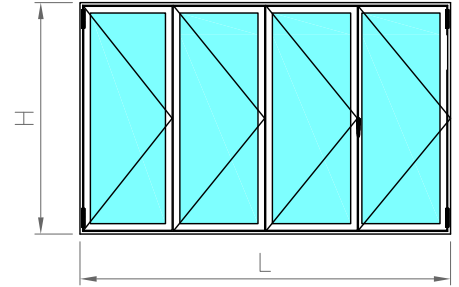













Central closure with 1 profiles 79102

N = número de hojas

N = number of sashes



FÓRMULAS DE CORTES | CUT FORMULAS

Perfiles de marco   Frame Profiles					
Sección   Section	Descripción   Description	Referencia   Cod.	Corte   Cut	Medida   Med.	Cantidad   Qty.
	Marco 77 mm <i>Frame 77 mm</i>	79100		L	2
				H	2
	Hoja 77 mm <i>Sash 77 mm</i>	79101		$[L - 66,2 - (N + 1) \times 12 - 51] / N$	$(N-1) \times 2$
				$[[L - 66,2 - (N + 1) \times 12 - 51] + 51] / N$	2
				H - 90,2	N x 2
	Complemento cerradura 77 mm <i>77 mm lock complement profile</i>	79102		H - 76,2	1
	Batiente <i>Profile support</i>	79103		L - 38,2	2
				H - 38,2	2
				H - 90	1
	Suplemento 14 mm <i>Supplement profile 14 mm</i>	79104		$[L - 66,2 - (N + 1) \times 12 - 51] / N$	$(N-1) \times 2$
				$[[L - 66,2 - (N + 1) \times 12 - 51] + 51] / N$	2
	Junquillo recto <i>Straight glazing</i>	(**)		$[L - 78,2 - (N \times 92) - 51] / N$	$(N-1) \times 2$
				$[[L - 78,2 - (N \times 92) - 51] / N] + 51$	2
				H - 210,2	N x 2

(\*\*) Seleccionar junquillos en página de acristalamientos

(\*\*) Select straight glazing on the glazing page

Vidrios   Glasses			
Medidas   Med.			Cantidad   Qty.
Con marco inferior 79100 <i>With bottom frame 79100</i>	$[L - 292 - (N - 2) \times 107 - 51] / N$	H - 185	N - 1
	$[[L - 292 - (N - 2) \times 107 - 51] / N] + 51$		1

**Plegable con MARCO INFERIOR 79100, CIERRE CENTRAL**

*Folding with LOWER FRAME 79100, CENTRAL CLOSURE*

Esquemas: 220, 321, 440, 541, 532, 660, 761, 752, 743, 880 y 853

*Scheme: 220, 321, 440, 541, 532, 660, 761, 752, 743, 880 and 853*

Cierre central sin perfiles 79102







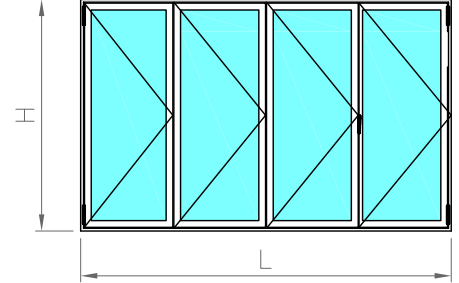











*Central closure without profiles 79102*

N = número de hojas

*N = number of sashes*



**FÓRMULAS DE CORTES | CUT FORMULAS**

Perfiles de marco   Frame Profiles					
Sección   Section	Descripción   Description	Referencia   Cod.	Corte   Cut	Medida   Med.	Cantidad   Qty.
	Marco 77 mm <i>Frame 77 mm</i>	79100		L	2
				H	2
	Hoja 77 mm <i>Sash 77 mm</i>	79101		$[L - 52,2 - (N + 1) \times 12 - 51] / N$	$(N-1) \times 2$
				$[[L - 52,2 - (N + 1) \times 12 - 51] + 51] / N$	2
				H - 90,2	N x 2
	Batiente <i>Profile support</i>	79103		L - 38,2	2
				H - 38,2	2
				H - 90	1
	Suplemento 14 mm <i>Supplement profile 14 mm</i>	79104		$[L - 52,2 - (N + 1) \times 12 - 51] / N$	$(N-1) \times 2$
				$[[L - 52,2 - (N + 1) \times 12 - 51] + 51] / N$	2
	Junquillo recto <i>Straight glazing</i>	(**)		$[L - 64,2 - (N \times 92) - 51] / N$	$(N-1) \times 2$
				$[[L - 64,2 - (N \times 92) - 51] / N] + 51$	2
				H - 210,2	N x 2

(\*\*) Seleccionar junquillos en página de acristalamientos

*(\*\*) Select straight glazing on the glazing page*

Vidrios   Glasses			
Medidas   Med.			Cantidad   Qty.
Con marco inferior 79100 <i>With bottom frame 79100</i>	$[L - 171,2 - (N - 1) \times 107 - 51] / N$	H - 185	N - 1
	$[[L - 171,2 - (N - 1) \times 107 - 51] / N] + 51$		1

Plegable con MARCO INFERIOR 79100, CIERRE CENTRAL

Folding with LOWER FRAME 79100, CENTRAL CLOSURE

Esquemas: 211, 431, 633, 651, 871 y 853

Scheme: 211, 431, 633, 651, 871 and 853

Cierre central con 2 perfiles 79102







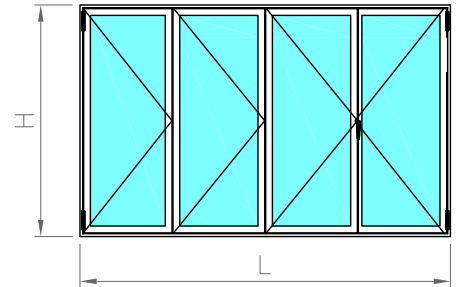









Central closure with 2 profiles 79102

N = número de hojas

N = number of sashes



FÓRMULAS DE CORTES | CUT FORMULAS

Perfiles de marco   Frame Profiles					
Sección   Section	Descripción   Description	Referencia   Cod.	Corte   Cut	Medida   Med.	Cantidad   Qty.
	Marco 77 mm <i>Frame 77 mm</i>	79100		L	2
				H	2
	Hoja 77 mm <i>Sash 77 mm</i>	79101		$[L - 80,2 - (N + 1) \times 12] / N$	N x 2
				H - 90,2	N x 2
	Complemento cerradura 77 mm <i>77 mm lock complement profile</i>	79102		H - 76,2	2
	Batiente <i>Profile support</i>	79103		L - 38,2	2
				H - 38,2	2
				H - 90	1
	Suplemento 14 mm <i>Supplement profile 14 mm</i>	79104		$[L - 80,2 - (N + 1) \times 12] / N$	N x 2
	Junquillo recto <i>Straight glazing</i>	(**)		$[L - 92,2 - (N \times 92)] / N$	N x 2
				H - 210,2	N x 2

(\*\*) Seleccionar junquillos en página de acristalamientos

(\*\*) Select straight glazing on the glazing page

Vidrios   Glasses			
Medidas   Med.			Cantidad   Qty.
Con marco inferior 79100 <i>With bottom frame 79100</i>	$[L - 306,2 - (N - 2) \times 107] / N$	H - 185	N

Solución inferior "A"  
Lower solution "A"

**Plegable con MARCO INFERIOR 79100, CIERRE CENTRAL**

*Folding with LOWER FRAME 79100, CENTRAL CLOSURE*

Esquemas: 211, 330, 431, 550, 633, 651, 770, 871 y 853

*Scheme: 211, 330, 431, 550, 633, 651, 770, 871 and 853*

Cierre central con 1 perfiles 79102







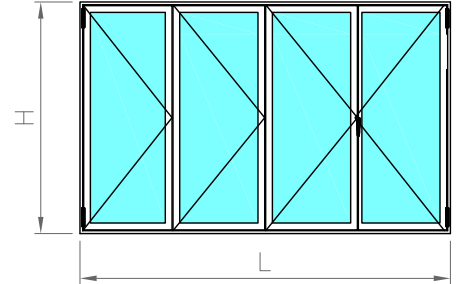









*Central closure with 1 profiles 79102*

N = número de hojas

*N = number of sashes*



**FÓRMULAS DE CORTES | CUT FORMULAS**

Perfiles de marco   Frame Profiles					
Sección   Section	Descripción   Description	Referencia   Cod.	Corte   Cut	Medida   Med.	Cantidad   Qty.
	Marco 77 mm <i>Frame 77 mm</i>	79100		L	2
				H	2
	Hoja 77 mm <i>Sash 77 mm</i>	79101		$[L - 66,2 - (N + 1) \times 12] / N$	N x 2
				H - 90,2	N x 2
	Complemento cerradura 77 mm <i>77 mm lock complement profile</i>	79102		H - 76,2	1
	Batiente <i>Profile support</i>	79103		L - 38,2	2
				H - 38,2	2
				H - 90	1
	Suplemento 14 mm <i>Supplement profile 14 mm</i>	79104		$[L - 66,2 - (N + 1) \times 12] / N$	N x 2
	Junquillo recto <i>Straight glazing</i>	(**)		$[L - 78,2 - (N \times 92)] / N$	N x 2
				H - 210,2	N x 2

(\*\*) Seleccionar junquillos en página de acristamientos

*(\*\*) Select straight glazing on the glazing page*

Vidrios   Glasses			
Medidas   Med.			Cantidad   Qty.
Con marco inferior 79100 <i>With bottom frame 79100</i>	$[L - 292 - (N - 2) \times 107] / N$	H - 185	N

**Plegable con MARCO INFERIOR 79100, CIERRE CENTRAL**

*Folding with LOWER FRAME 79100, CENTRAL CLOSURE*

Esquemas: 211, 330, 431, 550, 633, 651, 770, 871 y 853

*Scheme: 211, 330, 431, 550, 633, 651, 770, 871 and 853*

Cierre central sin perfiles 79102







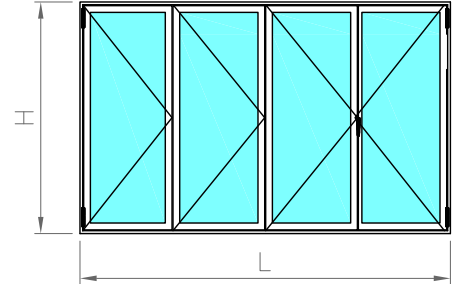







*Central closure without profiles 79102*

N = número de hojas

*N = number of sashes*



**FÓRMULAS DE CORTES | CUT FORMULAS**

Perfiles de marco   Frame Profiles					
Sección   Section	Descripción   Description	Referencia   Cod.	Corte   Cut	Medida   Med.	Cantidad   Qty.
	Marco 77 mm <i>Frame 77 mm</i>	79100		L	2
				H	2
	Hoja 77 mm <i>Sash 77 mm</i>	79101		$[L - 52,2 - (N + 1) \times 12] / N$	N x 2
				H - 90,2	N x 2
	Batiente <i>Profile support</i>	79103		L - 38,2	2
				H - 38,2	2
				H - 90	1
	Suplemento 14 mm <i>Supplement profile 14 mm</i>	79104		$[L - 52,2 - (N + 1) \times 12] / N$	N x 2
	Junquillo recto <i>Straight glazing</i>	(**)		$[L - 64,2 - (N \times 92)] / N$	N x 2
				H - 210,2	N x 2

(\*\*) Seleccionar junquillos en página de acristalamientos

*(\*\*) Select straight glazing on the glazing page*

Vidrios   Glasses			
Medidas   Med.			Cantidad   Qty.
Con marco inferior 79100 <i>With bottom frame 79100</i>	$[L - 171,2 - (N - 1) \times 107] / N$	H - 185	N

**Solución inferior "A"**  
*Lower solution "A"*

**Sección vertical con marco inferior 79100**  
*Vertical section with bottom frame 79106*

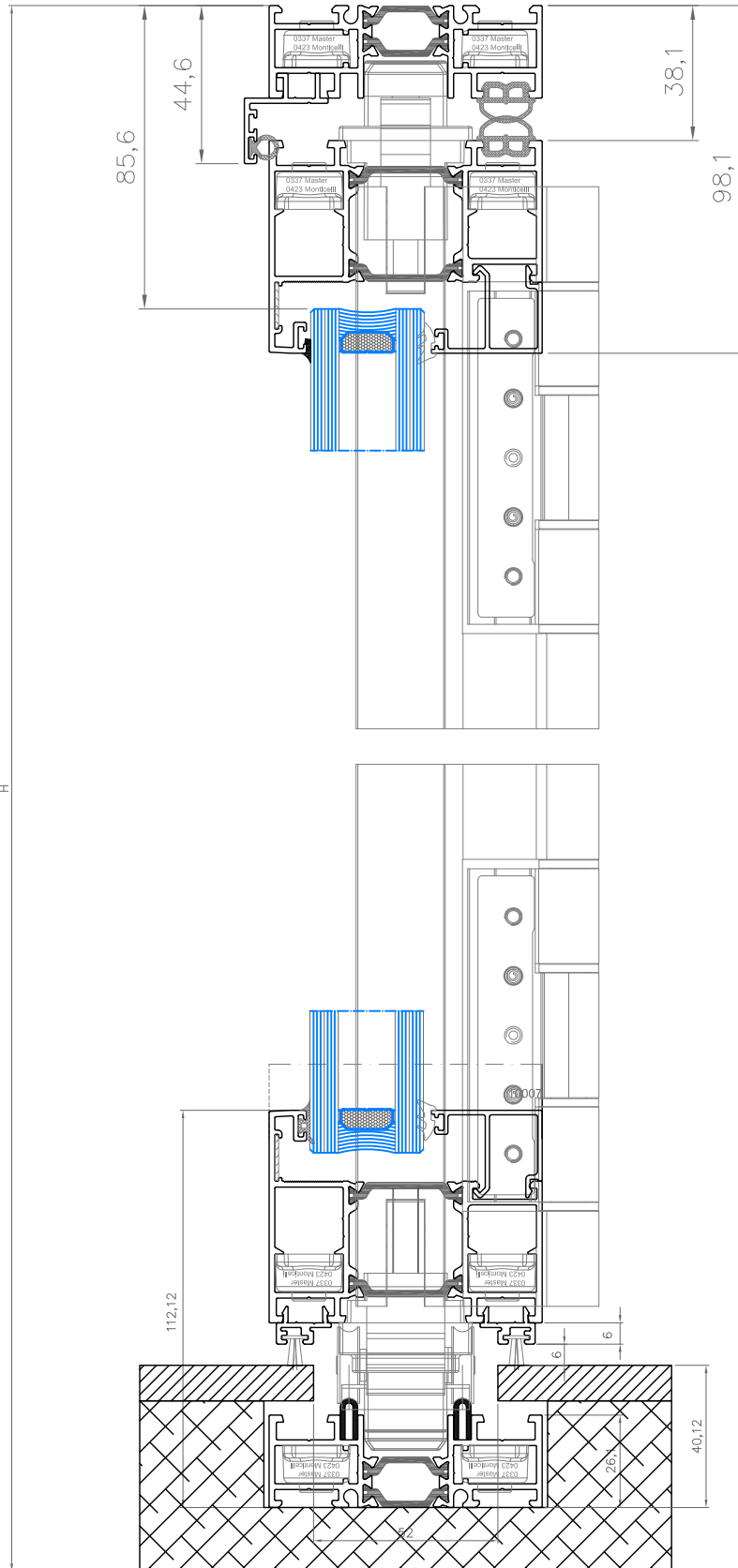

**Solución inferior "B"**  
*Lower solution "B"*



Plegable con MARCO INFERIOR 79100, CIERRE CENTRAL

Folding with LOWER FRAME 79100, CENTRAL CLOSURE

Esquemas: 422, 642, 844 y 862

Scheme: 422, 642, 844 y 862

Cierre central con 2 perfiles 79102







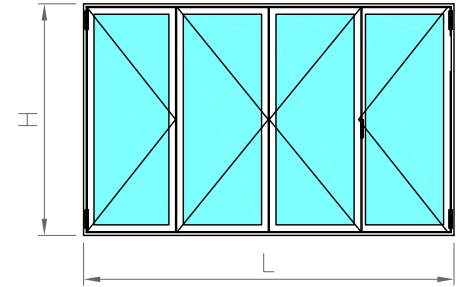











Central closure with 2 profiles 79102

N = número de hojas

N = number of sashes



FÓRMULAS DE CORTES | CUT FORMULAS

Perfiles de marco   Frame Profiles					
Sección   Section	Descripción   Description	Referencia   Cod.	Corte   Cut	Medida   Med.	Cantidad   Qty.
	Marco 77 mm <i>Frame 77 mm</i>	79100		L	2
				H	2
	Hoja 77 mm <i>Sash 77 mm</i>	79101		$[L - 80,2 - (N + 1) \times 12 - 102] / N$	(N-2) x 2
				$[[L - 80,2 - (N - 1) \times 12 - 102] / N] + 51$	4
				H - 90,2	N x 2
	Complemento cerradura 77 mm <i>77 mm lock complement profile</i>	79102		H - 76,2	2
	Batiante <i>Profile support</i>	79103		L - 38,2	1
				H - 59,2	1
				H - 59,2	1
	Complemento para felpudo <i>Profile Complement for felt</i>	79105		L / N (Medida aprox.)	N x 2
	Junquillo recto <i>Straight glazing</i>	(**)		$[L - 92,2 - (N \times 92) - 102] / N$	(N-2) x 2
				$[[L - 92,2 - (N \times 92) - 102] / N] + 51$	4
				H - 210,2	N x 2

(\*\*) Seleccionar junquillos en página de acristamientos

(\*\*) Select straight glazing on the glazing page

Vidrios   Glasses			
Medidas   Med.			Cantidad   Qty.
Con marco inferior 79100 <i>With bottom frame 79100</i>	$[L - 306,2 - (N - 2) \times 107 - 102] / N$	H - 185	N - 2
	$[[L - 306,2 - (N - 2) \times 107 - 102] / N] + 51$		2

Solución inferior "B"  
Lower solution "B"

Plegable con MARCO INFERIOR 79100, CIERRE CENTRAL

Folding with LOWER FRAME 79100, CENTRAL CLOSURE

Esquemas: 422, 642, 844 y 862

Scheme: 422, 642, 844 y 862

Cierre central con 1 perfiles 79102







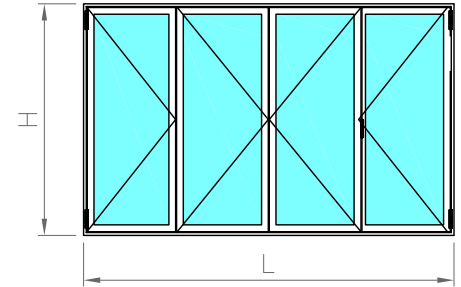











Central closure with 1 profiles 79102

N = número de hojas

N = number of sashes



FÓRMULAS DE CORTES | CUT FORMULAS

Perfiles de marco   Frame Profiles					
Sección   Section	Descripción   Description	Referencia   Cod.	Corte   Cut	Medida   Med.	Cantidad   Qty.
	Marco 77 mm Frame 77 mm	79100		L	2
				H	2
	Hoja 77 mm Sash 77 mm	79101		$[L - 66,2 - (N + 1) \times 12 - 102] / N$	$(N-2) \times 2$
				$[[L - 66,2 - (N - 1) \times 12 - 102] / N] + 51$	4
				H - 90,2	N x 2
	Complemento cerradura 77 mm 77 mm lock complement profile	79102		H - 76,2	1
	Batiente Profile support	79103		L - 38,2	1
				H - 59,2	1
				H - 59,2	1
	Complemento para felpudo Profile Complement for felt	79105		L / N (Medida aprox.)	N x 2
	Junquillo recto Straight glazing	(**)		$[L - 78,2 - (N \times 92) - 102] / N$	N x 2
				$[[L - 78,2 - (N \times 92) - 102] / N] + 51$	4
				H - 210,2	N x 2

(\*\*) Seleccionar junquillos en página de acristalamientos

(\*\*) Select straight glazing on the glazing page

Vidrios   Glasses			
Medidas   Med.			Cantidad   Qty.
Con marco inferior 79100 With bottom frame 79100	$[L - 292 - (N - 2) \times 107 - 102] / N$	H - 185	N - 2
	$[[L - 292 - (N - 2) \times 107 - 102] / N] + 51$		2

Solución inferior "B"  
Lower solution "B"

Plegable con MARCO INFERIOR 79100, CIERRE CENTRAL

Folding with LOWER FRAME 79100, CENTRAL CLOSURE

Esquemas: 422, 642, 844 y 862

Scheme: 422, 642, 844 y 862

Cierre central sin perfiles 79102







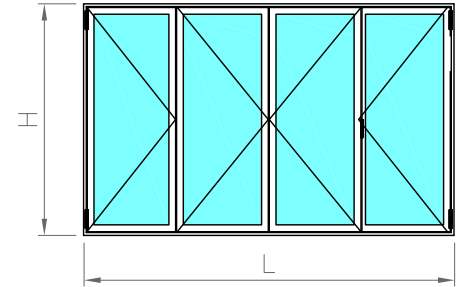









Central closure without profiles 79102

N = número de hojas

N = number of sashes



FÓRMULAS DE CORTES | CUT FORMULAS

Perfiles de marco   Frame Profiles					
Sección   Section	Descripción   Description	Referencia   Cod.	Corte   Cut	Medida   Med.	Cantidad   Qty.
	Marco 77 mm <i>Frame 77 mm</i>	79100		L	2
				H	2
	Hoja 77 mm <i>Sash 77 mm</i>	79101		$[L - 52,2 - (N + 1) \times 12 - 102] / N$	(N-2) x 2
				$[[L - 52,2 - (N - 1) \times 12 - 102] / N] + 51$	4
				H - 90,2	N x 2
	Batiente <i>Profile support</i>	79103		L - 38,2	1
				H - 59,2	1
				H - 59,2	1
	Complemento para felpudo <i>Profile Complement for felt</i>	79105		L / N (Medida aprox.)	N x 2
	Junquillo recto <i>Straight glazing</i>	(**)		$[L - 64,2 - (N \times 92) - 102] / N$	N x 2
				$[[L - 64,2 - (N \times 92) - 102] / N] + 51$	4
				H - 210,2	N x 2

(\*\*) Seleccionar junquillos en página de acristalamientos

(\*\*) Select straight glazing on the glazing page

Vidrios   Glasses			
Medidas   Med.			Cantidad   Qty.
Con marco inferior 79100 <i>With bottom frame 79100</i>	$[L - 171,2 - (N - 2) \times 107 - 102] / N$	H - 185	N - 2
	$[[L - 171,2 - (N - 2) \times 107 - 102] / N] + 51$		2

Solución inferior "B"  
Lower solution "B"

Plegable con MARCO INFERIOR 79100, CIERRE CENTRAL

Folding with LOWER FRAME 79100, CENTRAL CLOSURE

Esquemas: 321, 541, 532,761, 752 y 743

Scheme: 220, 321, 541, 532, 761, 752 and 743

Cierre central con 2 perfiles 79102







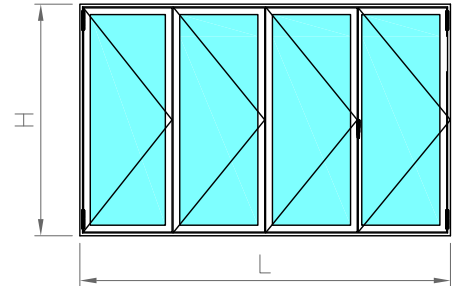













Central closure with 2 profiles 79102

N = número de hojas

N = number of sashes



FÓRMULAS DE CORTES | CUT FORMULAS

Perfiles de marco   Frame Profiles					
Sección   Section	Descripción   Description	Referencia   Cod.	Corte   Cut	Medida   Med.	Cantidad   Qty.
	Marco 77 mm Frame 77 mm	79100		L	2
				H	2
	Hoja 77 mm Sash 77 mm	79101		$[L - 80,2 - (N + 1) \times 12 - 51] / N$	$(N-1) \times 2$
				$[[L - 80,2 - (N - 1) \times 12 - 51] / N] + 51$	2
				H - 90,2	N x 2
	Complemento cerradura 77 mm 77 mm lock complement profile	79102		H - 76,2	2
	Batiente Profile support	79103		L - 38,2	1
				H - 59,2	1
				H - 59,2	1
				H - 97	1
	Complemento para felpudo Profile Complement for felt	79105		L / N (Medida aprox.)	N x 2
	Junquillo recto Straight glazing	(**)		$[L - 92,2 - (N \times 92) - 51] / N$	$(N-1) \times 2$
				$[[L - 92,2 - (N \times 92) - 51] / N] + 51$	2
				H - 210,2	N x 2

(\*\*) Seleccionar junquillos en página de acristamientos

(\*\*) Select straight glazing on the glazing page

Vidrios   Glasses			
Medidas   Med.			Cantidad   Qty.
Con marco inferior 79100 With bottom frame 79100	$[L - 306,2 - (N - 2) \times 107 - 51] / N$	H - 185	N - 1
	$[[L - 306,2 - (N - 2) \times 107 - 51] / N] + 51$		1

## Plegable con MARCO INFERIOR 79100, CIERRE CENTRAL

Folding with LOWER FRAME 79100, CENTRAL CLOSURE

Esquemas: 220, 321, 440, 541, 532, 660, 761, 752, 743 y 880

Scheme: 220, 321, 440, 541, 532, 660, 761, 752, 743 and 880

Cierre central con 1 perfiles 79102







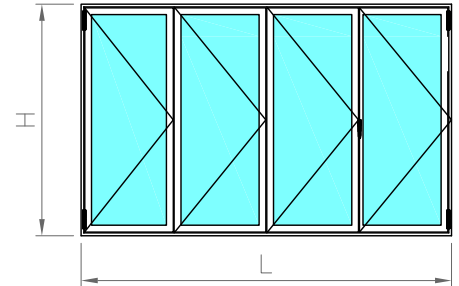













Central closure with 1 profiles 79102

N = número de hojas

N = number of sashes



## FÓRMULAS DE CORTES | CUT FORMULAS

Perfiles de marco   Frame Profiles					
Sección   Section	Descripción   Description	Referencia   Cod.	Corte   Cut	Medida   Med.	Cantidad   Qty.
	Marco 77 mm Frame 77 mm	79100		L	2
				H	2
	Hoja 77 mm Sash 77 mm	79101		$[L - 66,2 - (N + 1) \times 12 - 51] / N$	$(N-1) \times 2$
				$[[L - 66,2 - (N - 1) \times 12 - 51] / N] + 51$	2
				H - 90,2	N x 2
	Complemento cerradura 77 mm 77 mm lock complement profile	79102		H - 76,2	1
	Batiente Profile support	79103		L - 38,2	1
				H - 59,2	1
				H - 59,2	1
				H - 97	1
	Complemento para felpudo Profile Complement for felt	79105		L / N (Medida aprox.)	N x 2
	Junquillo recto Straight glazing	(**)		$[L - 78,2 - (N \times 92) - 51] / N$	$(N-1) \times 2$
				$[[L - 78,2 - (N \times 92) - 51] / N] + 51$	2
				H - 210,2	N x 2

(\*\*) Seleccionar junquillos en página de acristalamientos

(\*\*) Select straight glazing on the glazing page

Vidrios   Glasses			
Medidas   Med.			Cantidad   Qty.
Con marco inferior 79100 With bottom frame 79100	$[L - 292 - (N - 2) \times 107 - 51] / N$	H - 185	N - 1
	$[[L - 292 - (N - 2) \times 107 - 51] / N] + 51$		1

## Plegable con MARCO INFERIOR 79100, CIERRE CENTRAL

Folding with LOWER FRAME 79100, CENTRAL CLOSURE

Esquemas: 220, 321, 440, 541, 532, 660, 761, 752, 743 y 880

Scheme: 220, 321, 440, 541, 532, 660, 761, 752, 743 and 880

Cierre central sin perfiles 79102







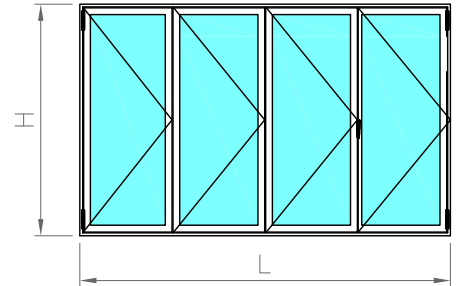











Central closure without profiles 79102

N = número de hojas

N = number of sashes



## FÓRMULAS DE CORTES | CUT FORMULAS

Perfiles de marco   Frame Profiles					
Sección   Section	Descripción   Description	Referencia   Cod.	Corte   Cut	Medida   Med.	Cantidad   Qty.
	Marco 77 mm Frame 77 mm	79100		L	2
				H	2
	Hoja 77 mm Sash 77 mm	79101		$[L - 52,2 - (N + 1) \times 12 - 51] / N$	(N-1) x 2
				$[[L - 52,2 - (N - 1) \times 12 - 51] / N] + 51$	2
				H - 90,2	N x 2
	Batiente Profile support	79103		L - 38,2	1
				H - 59,2	1
				H - 59,2	1
				H - 97	1
	Complemento para felpudo Profile Complement for felt	79105		L / N (Medida aprox.)	N x 2
	Junquillo recto Straight glazing	(**)		$[L - 64,2 - (N \times 92) - 51] / N$	(N-1) x 2
				$[[L - 64,2 - (N \times 92) - 51] / N] + 51$	2
				H - 210,2	N x 2

(\*\*) Seleccionar junquillos en página de acristamientos

(\*\*) Select straight glazing on the glazing page

Vidrios   Glasses			
Medidas   Med.			Cantidad   Qty.
Con marco inferior 79100 With bottom frame 79100	$[L - 171,2 - (N - 2) \times 107 - 51] / N$	H - 185	N - 1
	$[[L - 171,2 - (N - 2) \times 107 - 51] / N] + 51$		1

Solución inferior "B"  
Lower solution "B"

## Plegable con MARCO INFERIOR 79100, CIERRE CENTRAL

*Folding with LOWER FRAME 79100, CENTRAL CLOSURE*

Esquemas: 211, 330, 431, 633, 651, 871 y 853

*Scheme: 211, +431, 633, 651, 871 and 853*

Cierre central con 2 perfiles 79102







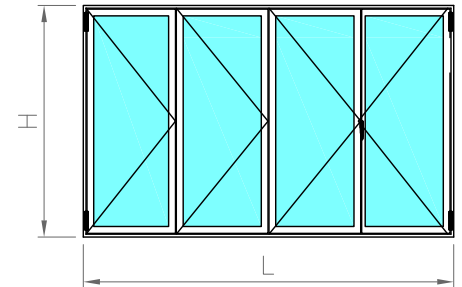











*Central closure with 2 profiles 79102*

N = número de hojas

*N = number of sashes*



## FÓRMULAS DE CORTES | CUT FORMULAS

Perfiles de marco   Frame Profiles					
Sección   Section	Descripción   Description	Referencia   Cod.	Corte   Cut	Medida   Med.	Cantidad   Qty.
	Marco 77 mm <i>Frame 77 mm</i>	79100		L	2
				H	2
	Hoja 77 mm <i>Sash 77 mm</i>	79101		$[L - 80,2 - (N + 1) \times 12] / N$	$N \times 2$
				H - 90,2	$N \times 2$
	Complemento cerradura 77 mm <i>77 mm lock complement profile</i>	79102		H - 76,2	2
	Batiente <i>Profile support</i>	79103		L - 38,2	1
				H - 59,2	1
				H - 59,2	1
				H - 97	1
	Complemento para felpudo <i>Profile Complement for felt</i>	79105		L / N (Medida aprox.)	$N \times 2$
	Junquillo recto <i>Straight glazing</i>	(**)		$[L - 92,2 - (N \times 92)] / N$	$N \times 2$
				H - 210,2	$N \times 2$

(\*\*) Seleccionar junquillos en página de acristalamientos

*(\*\*) Select straight glazing on the glazing page*

Vidrios   Glasses			
Medidas   Med.			Cantidad   Qty.
Con marco inferior 79100 <i>With bottom frame 79100</i>	$[L - 306,2 - (N - 2) \times 107] / N$	H - 185	N

**Plegable con MARCO INFERIOR 79100, CIERRE CENTRAL**

*Folding with LOWER FRAME 79100, CENTRAL CLOSURE*

Esquemas: 211, 330, 431, 550, 633, 651, 770, 871 y 853

*Scheme: 211, 330, 431, 550, 633, 651, 770, 871 and 853*

Cierre central con 1 perfiles 79102







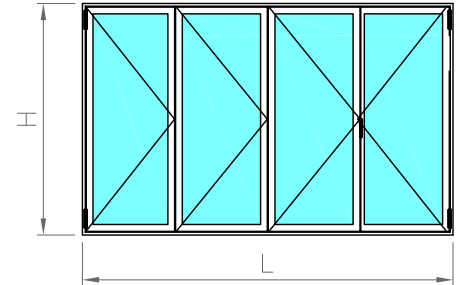











*Central closure with 1 profiles 79102*

N = número de hojas

*N = number of sashes*



**FÓRMULAS DE CORTES | CUT FORMULAS**

Perfiles de marco   Frame Profiles					
Sección   Section	Descripción   Description	Referencia   Cod.	Corte   Cut	Medida   Med.	Cantidad   Qty.
	Marco 77 mm <i>Frame 77 mm</i>	79100		L	2
				H	2
	Hoja 77 mm <i>Sash 77 mm</i>	79101		$[L - 80,2 - (N + 1) \times 12] / N$	$N \times 2$
				H - 90,2	$N \times 2$
	Complemento cerradura 77 mm <i>77 mm lock complement profile</i>	79102		H - 76,2	1
	Batiente <i>Profile support</i>	79103		L - 38,2	1
				H - 59,2	1
				H - 59,2	1
				H - 97	1
	Complemento para felpudo <i>Profile Complement for felt</i>	79105		L / N (Medida aprox.)	$N \times 2$
	Junquillo recto <i>Straight glazing</i>	(**)		$[L - 78,2 - (N \times 92)] / N$	$N \times 2$
				H - 210,2	$N \times 2$

(\*\*) Seleccionar junquillos en página de acristalamientos

*(\*\*) Select straight glazing on the glazing page*

Vidrios   Glasses			
Medidas   Med.			Cantidad   Qty.
Con marco inferior 79100 <i>With bottom frame 79100</i>	$[L - 292 - (N - 2) \times 107] / N$	H - 185	N

**Solución inferior "B"**  
*Lower solution "B"*



Plegable con MARCO INFERIOR 79100, CIERRE CENTRAL

Folding with LOWER FRAME 79100, CENTRAL CLOSURE

Esquemas: 211, 330, 431, 550, 633, 651, 770, 871 y 853

Scheme: 211, 330, 431, 550, 633, 651, 770, 871 and 853

Cierre central sin perfiles 79102







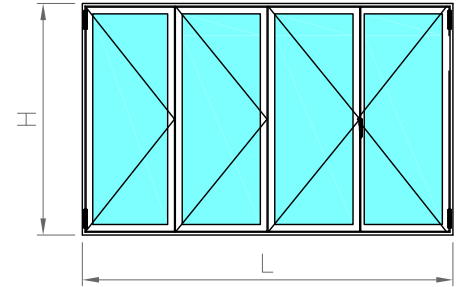









Central closure without profiles 79102

N = número de hojas

N = number of sashes



FÓRMULAS DE CORTES | CUT FORMULAS

Perfiles de marco   Frame Profiles					
Sección   Section	Descripción   Description	Referencia   Cod.	Corte   Cut	Medida   Med.	Cantidad   Qty.
	Marco 77 mm <i>Frame 77 mm</i>	79100		L	2
				H	2
	Hoja 77 mm <i>Sash 77 mm</i>	79101		$[L - 80,2 - (N + 1) \times 12] / N$	N x 2
				H - 90,2	N x 2
	Batiente <i>Profile support</i>	79103		L - 38,2	1
				H - 59,2	1
				H - 59,2	1
				H - 97	1
	Complemento para felpudo <i>Profile Complement for felt</i>	79105		L / N (Medida aprox.)	N x 2
	Junquillo recto <i>Straight glazing</i>	(**)		$[L - 64,2 - (N \times 92)] / N$	N x 2
				H - 210,2	N x 2

(\*\*) Seleccionar junquillos en página de acristalamientos

(\*\*) Select straight glazing on the glazing page

Vidrios   Glasses			
Medidas   Med.			Cantidad   Qty.
Con marco inferior 79100 <i>With bottom frame 79100</i>	$[L - 171,2 - (N - 2) \times 107] / N$	H - 185	N

Solución inferior "B"  
Lower solution "B"

**Sección vertical con marco inferior 79100**  
*Vertical section with bottom frame 79100*

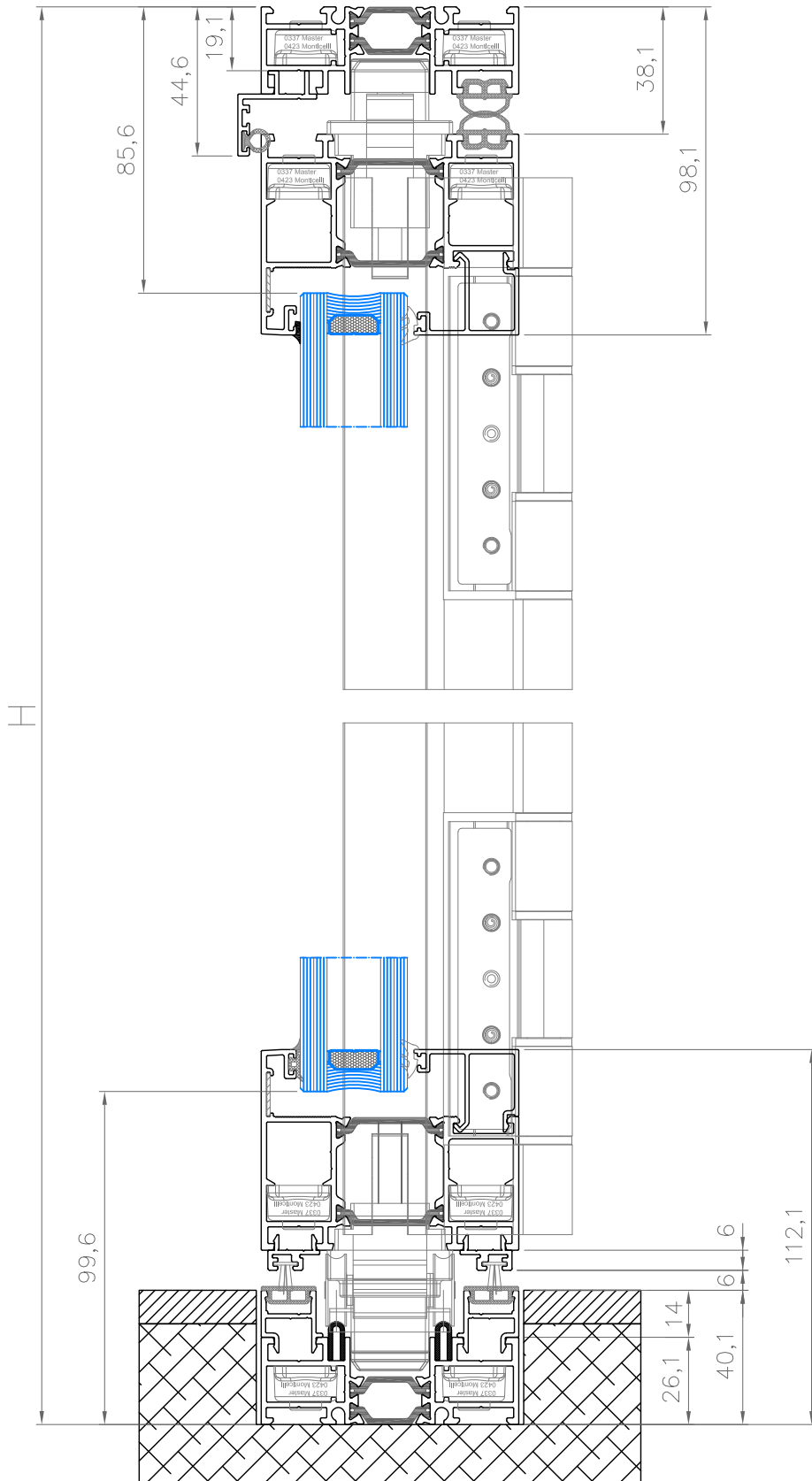

**Solución inferior "C"**  
*Lower solution "C"*

Plegable con MARCO INFERIOR 79100, CIERRE CENTRAL

Folding with LOWER FRAME 79100, CENTRAL CLOSURE

Esquemas: 422, 642, 844 y 862

Scheme: 422, 642, 844 y 862

Cierre central con 2 perfiles 79102







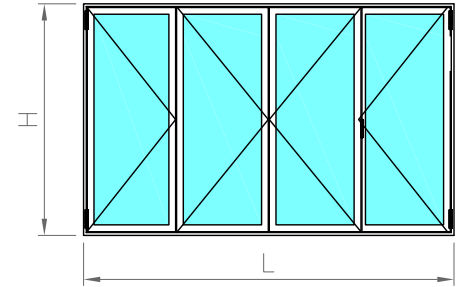













Central closure with 2 profiles 79102

N = número de hojas

N = number of sashes



FÓRMULAS DE CORTES | CUT FORMULAS

Perfiles de marco   Frame Profiles					
Sección   Section	Descripción   Description	Referencia   Cod.	Corte   Cut	Medida   Med.	Cantidad   Qty.
	Marco 77 mm <i>Frame 77 mm</i>	79100		L	2
				H	2
	Hoja 77 mm <i>Sash 77 mm</i>	79101		$[L - 80,2 - (N + 1) \times 12 - 102] / N$	(N-2) x 2
				$[[L - 80,2 - (N - 1) \times 12 - 102] / N] + 51$	4
				H - 90,2	N x 2
	Complemento cerradura 77 mm <i>77 mm lock complement profile</i>	79102		H - 76,2	2
	Batiante <i>Profile support</i>	79103		L - 38,2	1
				H - 59,2	1
				H - 59,2	1
	Suplemento 14 mm <i>Supplement profile 14 mm</i>	79104		L - 52,2	N x 2
	Complemento para felpudo <i>Profile Complement for felt</i>	79105		L / N (Medida aprox.)	N x 2
	Junquillo recto <i>Straight glazing</i>	(**)		$[L - 92,2 - (N \times 92) - 102] / N$	(N-2) x 2
				$[[L - 92,2 - (N \times 92) - 102] / N] + 51$	4
				H - 210,2	N x 2

(\*\*) Seleccionar junquillos en página de acristamientos

(\*\*) Select straight glazing on the glazing page

Vidrios   Glasses			
Medidas   Med.			Cantidad   Qty.
Con marco inferior 79100 <i>With bottom frame 79100</i>	$[L - 306,2 - (N - 2) \times 107 - 102] / N$	H - 185	N - 2
	$[[L - 306,2 - (N - 2) \times 107 - 102] / N] + 51$		2

Plegable con MARCO INFERIOR 79100, CIERRE CENTRAL

Folding with LOWER FRAME 79100, CENTRAL CLOSURE

Esquemas: 422, 642, 844 y 862

Scheme: 422, 642, 844 y 862

Cierre central con 1 perfiles 79102







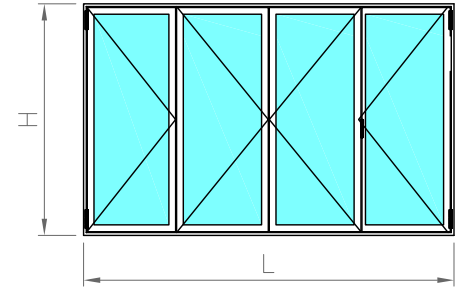













Central closure with 1 profiles 79102

N = número de hojas

N = number of sashes



FÓRMULAS DE CORTES | CUT FORMULAS

Perfiles de marco   Frame Profiles					
Sección   Section	Descripción   Description	Referencia   Cod.	Corte   Cut	Medida   Med.	Cantidad   Qty.
	Marco 77 mm <i>Frame 77 mm</i>	79100		L	2
				H	2
	Hoja 77 mm <i>Sash 77 mm</i>	79101		$[L - 66,2 - (N + 1) \times 12 - 102] / N$	(N-2) x 2
				$[[L - 66,2 - (N - 1) \times 12 - 102] / N] + 51$	4
				H - 90,2	N x 2
	Complemento cerradura 77 mm <i>77 mm lock complement profile</i>	79102		H - 76,2	1
	Batiente <i>Profile support</i>	79103		L - 38,2	1
				H - 59,2	1
				H - 59,2	1
	Suplemento 14 mm <i>Supplement profile 14 mm</i>	79104		L - 52,2	N x 2
	Complemento para felpudo <i>Profile Complement for felt</i>	79105		L / N (Medida aprox.)	N x 2
	Junquillo recto <i>Straight glazing</i>	(**)		$[L - 78,2 - (N \times 92) - 102] / N$	N x 2
				$[[L - 78,2 - (N \times 92) - 102] / N] + 51$	4
				H - 210,2	N x 2

(\*\*) Seleccionar junquillos en página de acristalamientos

(\*\*) Select straight glazing on the glazing page

Vidrios   Glasses			
Medidas   Med.			Cantidad   Qty.
Con marco inferior 79100 <i>With bottom frame 79100</i>	$[L - 292 - (N - 2) \times 107 - 102] / N$	H - 185	N - 2
	$[[L - 292 - (N - 2) \times 107 - 102] / N] + 51$		2

Plegable con MARCO INFERIOR 79100, CIERRE CENTRAL

Folding with LOWER FRAME 79100, CENTRAL CLOSURE

Esquemas: 422, 642, 844 y 862

Scheme: 422, 642, 844 y 862

Cierre central sin perfiles 79102







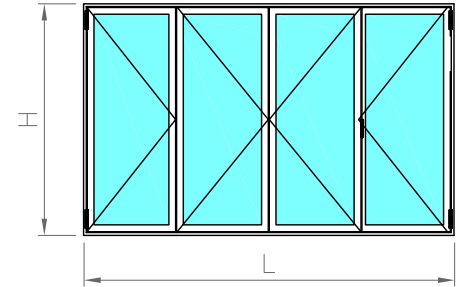











Central closure without profiles 79102

N = número de hojas

N = number of sashes



FÓRMULAS DE CORTES | CUT FORMULAS

Perfiles de marco   Frame Profiles					
Sección   Section	Descripción   Description	Referencia   Cod.	Corte   Cut	Medida   Med.	Cantidad   Qty.
	Marco 77 mm <i>Frame 77 mm</i>	79100		L	2
				H	2
	Hoja 77 mm <i>Sash 77 mm</i>	79101		$[L - 52,2 - (N + 1) \times 12 - 102] / N$	(N-2) x 2
				$[[L - 52,2 - (N - 1) \times 12 - 102] / N] + 51$	4
				H - 90,2	N x 2
	Batiante <i>Profile support</i>	79103		L - 38,2	1
				H - 59,2	1
				H - 59,2	1
	Suplemento 14 mm <i>Supplement profile 14 mm</i>	79104		L - 52,2	N x 2
	Complemento para felpudo <i>Profile Complement for felt</i>	79105		L / N (Medida aprox.)	N x 2
	Junquillo recto <i>Straight glazing</i>	(**)		$[L - 64,2 - (N \times 92) - 102] / N$	N x 2
				$[[L - 64,2 - (N \times 92) - 102] / N] + 51$	4
				H - 210,2	N x 2

(\*\*) Seleccionar junquillos en página de acristamientos

(\*\*) Select straight glazing on the glazing page

Vidrios   Glasses			
Medidas   Med.			Cantidad   Qty.
Con marco inferior 79100 <i>With bottom frame 79100</i>	$[L - 171,2 - (N - 2) \times 107 - 102] / N$	H - 185	N - 2
	$[[L - 171,2 - (N - 2) \times 107 - 102] / N] + 51$		2

**Plegable con MARCO INFERIOR 79100, CIERRE CENTRAL**

*Folding with LOWER FRAME 79100, CENTRAL CLOSURE*

Esquemas: 321, 541, 532, 660, 761, 752 y 743

*Scheme: 321, 541, 532, 761, 752 and 743*

Cierre central con 2 perfiles 79102







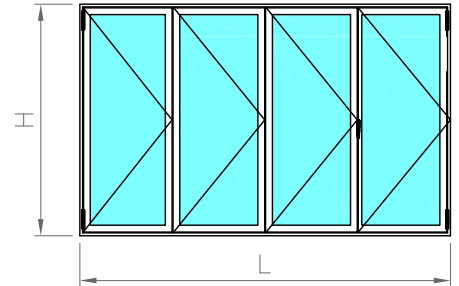















*Central closure with 2 profiles 79102*

N = número de hojas

*N = number of sashes*



**FÓRMULAS DE CORTES | CUT FORMULAS**

Perfiles de marco   Frame Profiles					
Sección   Section	Descripción   Description	Referencia   Cod.	Corte   Cut	Medida   Med.	Cantidad   Qty.
	Marco 77 mm <i>Frame 77 mm</i>	79100		L	2
				H	2
	Hoja 77 mm <i>Sash 77 mm</i>	79101		$[L - 80,2 - (N + 1) \times 12 - 51] / N$	$(N-1) \times 2$
				$[[L - 80,2 - (N - 1) \times 12 - 51] / N] + 51$	2
				H - 90,2	N x 2
	Complemento cerradura 77 mm <i>77 mm lock complement profile</i>	79102		H - 76,2	2
	Batiente <i>Profile support</i>	79103		L - 38,2	1
				H - 59,2	1
				H - 59,2	1
				H - 97	1
	Suplemento 14 mm <i>Supplement profile 14 mm</i>	79104		L - 52,2	N x 2
	Complemento para felpudo <i>Profile Complement for felt</i>	79105		L / N (Medida aprox.)	N x 2
	Junquillo recto <i>Straight glazing</i>	(**)		$[L - 92,2 - (N \times 92) - 51] / N$	$(N-1) \times 2$
				$[[L - 92,2 - (N \times 92) - 51] / N] + 51$	2
				H - 210,2	N x 2

(\*\*) Seleccionar junquillos en página de acristalamientos

*(\*\*) Select straight glazing on the glazing page*

Vidrios   Glasses			
Medidas   Med.			Cantidad   Qty.
Con marco inferior 79100 <i>With bottom frame 79100</i>	$[L - 306,2 - (N - 2) \times 107 - 51] / N$	H - 185	N - 1
	$[[L - 306,2 - (N - 2) \times 107 - 51] / N] + 51$		1

**Plegable con MARCO INFERIOR 79100, CIERRE CENTRAL**

*Folding with LOWER FRAME 79100, CENTRAL CLOSURE*

Esquemas: 220, 321, 440, 541, 532, 660, 761, 752, 743 y 880

*Scheme: 220, 321, 440, 541, 532, 660, 761, 752, 743 and 880*

Cierre central con 1 perfiles 79102







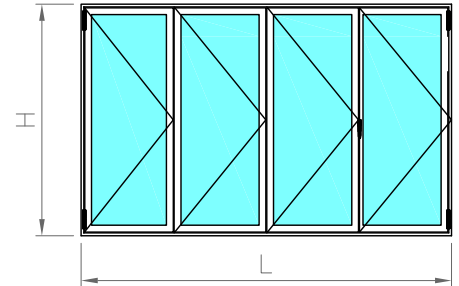















*Central closure with 1 profiles 79102*

N = número de hojas

*N = number of sashes*



**FÓRMULAS DE CORTES | CUT FORMULAS**

Perfiles de marco   Frame Profiles					
Sección   Section	Descripción   Description	Referencia   Cod.	Corte   Cut	Medida   Med.	Cantidad   Qty.
	Marco 77 mm <i>Frame 77 mm</i>	79100		L	2
				H	2
	Hoja 77 mm <i>Sash 77 mm</i>	79101		$[L - 66,2 - (N + 1) \times 12 - 51] / N$	$(N-1) \times 2$
				$[[L - 66,2 - (N - 1) \times 12 - 51] / N] + 51$	2
				H - 90,2	N x 2
	Complemento cerradura 77 mm <i>77 mm lock complement profile</i>	79102		H - 76,2	1
	Batiente <i>Profile support</i>	79103		L - 38,2	1
				H - 59,2	1
				H - 59,2	1
				H - 97	1
	Suplemento 14 mm <i>Supplement profile 14 mm</i>	79104		L - 52,2	N x 2
	Complemento para felpudo <i>Profile Complement for felt</i>	79105		L / N (Medida aprox.)	N x 2
	Junquillo recto <i>Straight glazing</i>	(**)		$[L - 78,2 - (N \times 92) - 51] / N$	$(N-1) \times 2$
				$[[L - 78,2 - (N \times 92) - 51] / N] + 51$	2
				H - 210,2	N x 2

(\*\*) Seleccionar junquillos en página de acristalamientos

*(\*\*) Select straight glazing on the glazing page*

Vidrios   Glasses			
Medidas   Med.			Cantidad   Qty.
Con marco inferior 79100 <i>With bottom frame 79100</i>	$[L - 292 - (N - 2) \times 107 - 51] / N$	H - 185	N - 1
	$[[L - 292 - (N - 2) \times 107 - 51] / N] + 51$		1

## Plegable con MARCO INFERIOR 79100, CIERRE CENTRAL

Folding with LOWER FRAME 79100, CENTRAL CLOSURE

Esquemas: 220, 321, 440, 541, 532, 660, 761, 752, 743 y 880

Scheme: 220, 321, 440, 541, 532, 660, 761, 752, 743 and 880

Cierre central sin perfiles 79102







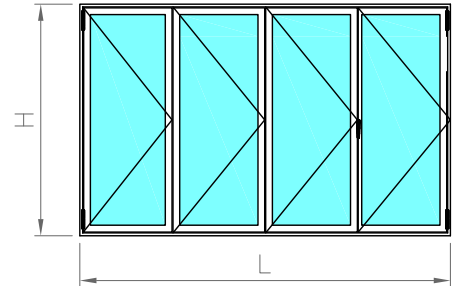













Central closure without profiles 79102

N = número de hojas

N = number of sashes



## FÓRMULAS DE CORTES | CUT FORMULAS

Perfiles de marco   Frame Profiles					
Sección   Section	Descripción   Description	Referencia   Cod.	Corte   Cut	Medida   Med.	Cantidad   Qty.
	Marco 77 mm <i>Frame 77 mm</i>	79100		L	2
				H	2
	Hoja 77 mm <i>Sash 77 mm</i>	79101		$[L - 52,2 - (N + 1) \times 12 - 51] / N$	$(N-1) \times 2$
				$[[L - 52,2 - (N - 1) \times 12 - 51] / N] + 51$	2
				H - 90,2	N x 2
	Batiente <i>Profile support</i>	79103		L - 38,2	1
				H - 59,2	1
				H - 59,2	1
				H - 97	1
	Suplemento 14 mm <i>Supplement profile 14 mm</i>	79104		L - 52,2	N x 2
	Complemento para felpudo <i>Profile Complement for felt</i>	79105		L / N (Medida aprox.)	N x 2
	Junquillo recto <i>Straight glazing</i>	(**)		$[L - 64,2 - (N \times 92) - 51] / N$	$(N-1) \times 2$
				$[[L - 64,2 - (N \times 92) - 51] / N] + 51$	2
				H - 210,2	N x 2

(\*\*) Seleccionar junquillos en página de acristamientos

(\*\*) Select straight glazing on the glazing page

Vidrios   Glasses			
Medidas   Med.			Cantidad   Qty.
Con marco inferior 79100 <i>With bottom frame 79100</i>	$[L - 171,2 - (N - 2) \times 107 - 51] / N$	H - 185	N - 1
	$[[L - 171,2 - (N - 2) \times 107 - 51] / N] + 51$		1



Plegable con MARCO INFERIOR 79100, CIERRE CENTRAL

Folding with LOWER FRAME 79100, CENTRAL CLOSURE

Esquemas: 211, 431, 633, 651, 871 y 853

Scheme: 211, 431, 633, 651, 871 and 853

Cierre central con 2 perfiles 79102







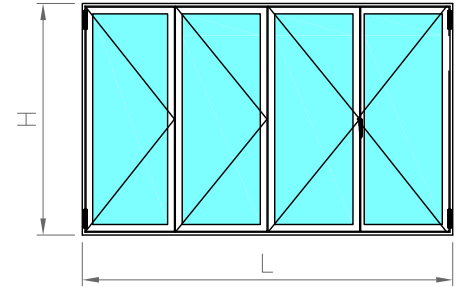













Central closure with 2 profiles 79102

N = número de hojas

N = number of sashes



FÓRMULAS DE CORTES | CUT FORMULAS

Perfiles de marco   Frame Profiles					
Sección   Section	Descripción   Description	Referencia   Cod.	Corte   Cut	Medida   Med.	Cantidad   Qty.
	Marco 77 mm <i>Frame 77 mm</i>	79100		L	2
				H	2
	Hoja 77 mm <i>Sash 77 mm</i>	79101		$[L - 80,2 - (N + 1) \times 12] / N$	N x 2
				H - 90,2	N x 2
	Complemento cerradura 77 mm <i>77 mm lock complement profile</i>	79102		H - 76,2	2
	Batiente <i>Profile support</i>	79103		L - 38,2	1
				H - 59,2	1
				H - 59,2	1
				H - 97	1
	Suplemento 14 mm <i>Supplement profile 14 mm</i>	79104		L - 52,2	N x 2
	Complemento para felpudo <i>Profile Complement for felt</i>	79105		L / N (Medida aprox.)	N x 2
	Junquillo recto <i>Straight glazing</i>	(**)		$[L - 92,2 - (N \times 92)] / N$	N x 2
				H - 210,2	N x 2

(\*\*) Seleccionar junquillos en página de acristalamientos

(\*\*) Select straight glazing on the glazing page

Vidrios   Glasses			
Medidas   Med.			Cantidad   Qty.
Con marco inferior 79100 <i>With bottom frame 79100</i>	$[L - 306,2 - (N - 2) \times 107] / N$	H - 185	N

Plegable con MARCO INFERIOR 79100, CIERRE CENTRAL

Folding with LOWER FRAME 79100, CENTRAL CLOSURE

Esquemas: 211, 330, 431, 550, 633, 651, 770, 871 y 853

Scheme: 211, 330, 431, 550, 633, 651, 770, 871 and 853

Cierre central con 1 perfiles 79102







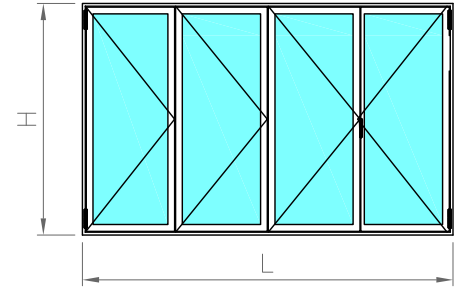













Central closure with 1 profiles 79102

N = número de hojas

N = number of sashes



FÓRMULAS DE CORTES | CUT FORMULAS

Perfiles de marco   Frame Profiles					
Sección   Section	Descripción   Description	Referencia   Cod.	Corte   Cut	Medida   Med.	Cantidad   Qty.
	Marco 77 mm <i>Frame 77 mm</i>	79100		L	2
				H	2
	Hoja 77 mm <i>Sash 77 mm</i>	79101		$[L - 80,2 - (N + 1) \times 12] / N$	N x 2
				H - 90,2	N x 2
	Complemento cerradura 77 mm <i>77 mm lock complement profile</i>	79102		H - 76,2	1
	Batiente <i>Profile support</i>	79103		L - 38,2	1
				H - 59,2	1
				H - 59,2	1
				H - 97	1
	Suplemento 14 mm <i>Supplement profile 14 mm</i>	79104		L - 52,2	N x 2
	Complemento para felpudo <i>Profile Complement for felt</i>	79105		L / N (Medida aprox.)	N x 2
	Junquillo recto <i>Straight glazing</i>	(**)		$[L - 78,2 - (N \times 92)] / N$	N x 2
				H - 210,2	N x 2

(\*\*) Seleccionar junquillos en página de acristalamientos

(\*\*) Select straight glazing on the glazing page

Vidrios   Glasses			
Medidas   Med.			Cantidad   Qty.
Con marco inferior 79100 <i>With bottom frame 79100</i>	$[L - 292 - (N - 2) \times 107] / N$	H - 185	N

Solución inferior "C"  
Lower solution "C"

**Plegable con MARCO INFERIOR 79100, CIERRE CENTRAL**

*Folding with LOWER FRAME 79100, CENTRAL CLOSURE*

Esquemas: 211, 330, 431, 550, 633, 651, 770, 871 y 853

*Scheme: 211, 330, 431, 550, 633, 651, 770, 871 and 853*

Cierre central sin perfiles 79102







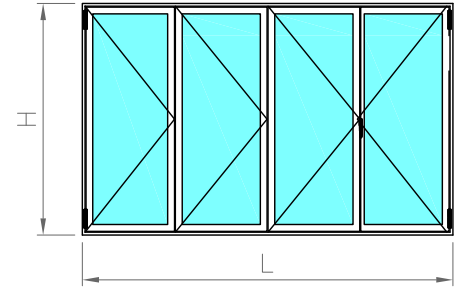











*Central closure without profiles 79102*

N = número de hojas

*N = number of sashes*



**FÓRMULAS DE CORTES | CUT FORMULAS**

Perfiles de marco   Frame Profiles					
Sección   Section	Descripción   Description	Referencia   Cod.	Corte   Cut	Medida   Med.	Cantidad   Qty.
	Marco 77 mm <i>Frame 77 mm</i>	79100		L	2
				H	2
	Hoja 77 mm <i>Sash 77 mm</i>	79101		$[L - 80,2 - (N + 1) \times 12] / N$	$N \times 2$
				H - 90,2	$N \times 2$
	Batiente <i>Profile support</i>	79103		L - 38,2	1
				H - 59,2	1
				H - 59,2	1
				H - 97	1
	Suplemento 14 mm <i>Supplement profile 14 mm</i>	79104		L - 52,2	$N \times 2$
	Complemento para felpudo <i>Profile Complement for felt</i>	79105		L / N (Medida aprox.)	$N \times 2$
	Junquillo recto <i>Straight glazing</i>	(**)		$[L - 64,2 - (N \times 92)] / N$	$N \times 2$
				H - 210,2	$N \times 2$

(\*\*) Seleccionar junquillos en página de acristalamientos

*(\*\*) Select straight glazing on the glazing page*

Vidrios   Glasses			
Medidas   Med.			Cantidad   Qty.
Con marco inferior 79100 <i>With bottom frame 79100</i>	$[L - 171,2 - (N - 2) \times 107] / N$	H - 185	N

**Solución inferior "C"**  
*Lower solution "C"*

**Sección vertical con marco inferior 79100**  
*Vertical section with bottom frame 79100*

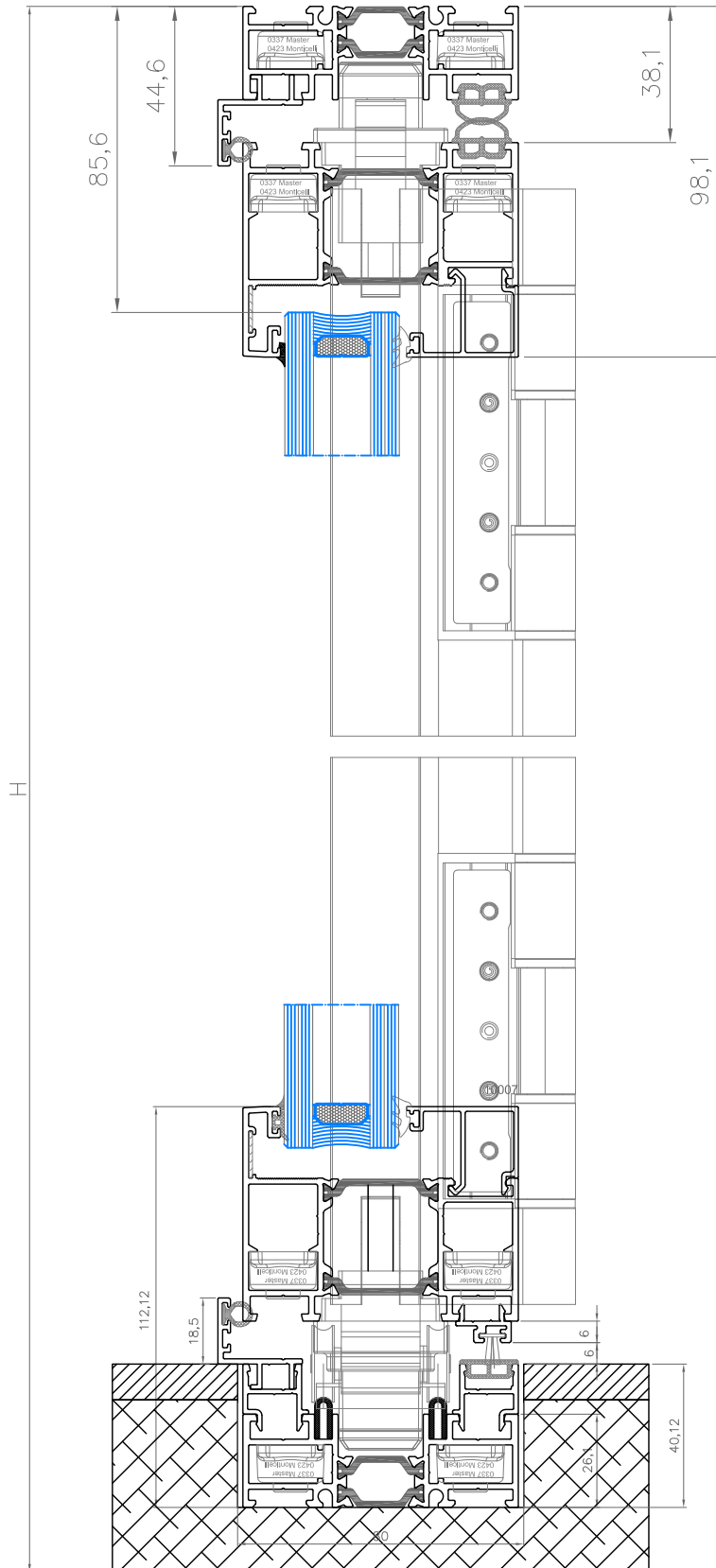

## Plegable con MARCO INFERIOR 79100, CIERRE CENTRAL

Folding with LOWER FRAME 79100, CENTRAL CLOSURE

Esquemas: 422, 642, 844 y 862

Scheme: 422, 642, 844 y 862

Cierre central con 2 perfiles 79102







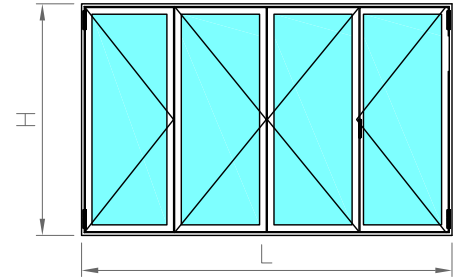













Central closure with 2 profiles 79102

N = número de hojas

N = number of sashes



## FÓRMULAS DE CORTES | CUT FORMULAS

Perfiles de marco   Frame Profiles					
Sección   Section	Descripción   Description	Referencia   Cod.	Corte   Cut	Medida   Med.	Cantidad   Qty.
	Marco 77 mm <i>Frame 77 mm</i>	79100		L	2
				H	2
	Hoja 77 mm <i>Sash 77 mm</i>	79101		$[L - 80,2 - (N + 1) \times 12 - 102] / N$	$(N-2) \times 2$
				$[[L - 80,2 - (N - 1) \times 12 - 102] / N] + 51$	4
				H - 90,2	N x 2
	Complemento cerradura 77 mm <i>77 mm lock complement profile</i>	79102		H - 76,2	2
	Batiente <i>Profile support</i>	79103		L - 38,2	2
				H - 38,2	2
	Suplemento 14 mm <i>Supplement profile 14 mm</i>	79104		L - 52,2	N x 2
	Complemento para felpudo <i>Profile Complement for felt</i>	79105		L / N (Medida aprox.)	N
	Junquillo recto <i>Straight glazing</i>	(**)		$[L - 92,2 - (N \times 92) - 102] / N$	$(N-2) \times 2$
				$[[L - 92,2 - (N \times 92) - 102] / N] + 51$	4
				H - 210,2	N x 2

(\*\*) Seleccionar junquillos en página de acristalamientos

(\*\*) Select straight glazing on the glazing page

Vidrios   Glasses			
Medidas   Med.			Cantidad   Qty.
Con marco inferior 79100 <i>With bottom frame 79100</i>	$[L - 306,2 - (N - 2) \times 107 - 102] / N$	H - 185	N - 2
	$[[L - 306,2 - (N - 2) \times 107 - 102] / N] + 51$		2

Solución inferior "D"  
Lower solution "D"

Plegable con MARCO INFERIOR 79100, CIERRE CENTRAL

Folding with LOWER FRAME 79100, CENTRAL CLOSURE

Esquemas: 422, 642, 844 y 862

Scheme: 422, 642, 844 y 862

Cierre central con 1 perfiles 79102







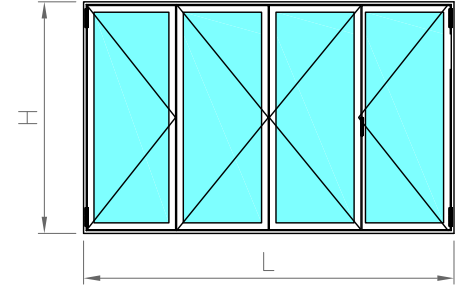













Central closure with 1 profiles 79102

N = número de hojas

N = number of sashes



FÓRMULAS DE CORTES | CUT FORMULAS

Perfiles de marco   Frame Profiles					
Sección   Section	Descripción   Description	Referencia   Cod.	Corte   Cut	Medida   Med.	Cantidad   Qty.
	Marco 77 mm Frame 77 mm	79100		L	2
				H	2
	Hoja 77 mm Sash 77 mm	79101		$[L - 66,2 - (N + 1) \times 12 - 102] / N$	$(N-2) \times 2$
				$[[L - 66,2 - (N - 1) \times 12 - 102] / N] + 51$	4
				H - 90,2	N x 2
	Complemento cerradura 77 mm 77 mm lock complement profile	79102		H - 76,2	1
	Batiente Profile support	79103		L - 38,2	2
				H - 38,2	2
	Suplemento 14 mm Supplement profile 14 mm	79104		L - 52,2	N x 2
	Complemento para felpudo Profile Complement for felt	79105		L / N (Medida aprox.)	N
	Junquillo recto Straight glazing	(**)		$[L - 78,2 - (N \times 92) - 102] / N$	$(N-2) \times 2$
				$[[L - 78,2 - (N \times 92) - 102] / N] + 51$	4
				H - 210,2	N x 2

(\*\*) Seleccionar junquillos en página de acristalamientos

(\*\*) Select straight glazing on the glazing page

Vidrios   Glasses			
Medidas   Med.			Cantidad   Qty.
Con marco inferior 79100 With bottom frame 79100	$[L - 292 - (N - 2) \times 107 - 102] / N$	H - 185	N - 2
	$[[L - 292 - (N - 2) \times 107 - 102] / N] + 51$		2

Solución inferior "D"  
Lower solution "D"

Plegable con MARCO INFERIOR 79100, CIERRE CENTRAL

Folding with LOWER FRAME 79100, CENTRAL CLOSURE

Esquemas: 422, 642, 844 y 862

Scheme: 422, 642, 844 y 862

Cierre central sin perfiles 79102







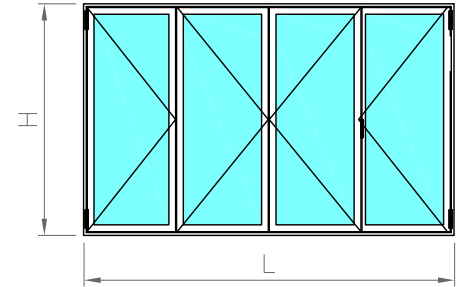











Central closure without profiles 79102

N = número de hojas

N = number of sashes



FÓRMULAS DE CORTES | CUT FORMULAS

Perfiles de marco   Frame Profiles					
Sección   Section	Descripción   Description	Referencia   Cod.	Corte   Cut	Medida   Med.	Cantidad   Qty.
	Marco 77 mm <i>Frame 77 mm</i>	79100		L	2
				H	2
	Hoja 77 mm <i>Sash 77 mm</i>	79101		$[L - 52,2 - (N + 1) \times 12 - 102] / N$	$(N-2) \times 2$
				$[[L - 52,2 - (N - 1) \times 12 - 102] / N] + 51$	4
				H - 90,2	N x 2
	Batiente <i>Profile support</i>	79103		L - 38,2	2
				H - 38,2	2
	Suplemento 14 mm <i>Supplement profile 14 mm</i>	79104		L - 52,2	N x 2
	Complemento para felpudo <i>Profile Complement for felt</i>	79105		L / N (Medida aprox.)	N
	Junquillo recto <i>Straight glazing</i>	(**)		$[L - 64,2 - (N \times 92) - 102] / N$	$(N-2) \times 2$
				$[[L - 64,2 - (N \times 92) - 102] / N] + 51$	4
				H - 210,2	N x 2

(\*\*) Seleccionar junquillos en página de acristalamientos

(\*\*) Select straight glazing on the glazing page

Vidrios   Glasses			
Medidas   Med.			Cantidad   Qty.
Con marco inferior 79100 <i>With bottom frame 79100</i>	$[L - 171,2 - (N - 2) \times 107 - 102] / N$	H - 185	N - 2
	$[[L - 171,2 - (N - 2) \times 107 - 102] / N] + 51$		2

Solución inferior "D"  
Lower solution "D"

Plegable con MARCO INFERIOR 79100, CIERRE CENTRAL

Folding with LOWER FRAME 79100, CENTRAL CLOSURE

Esquemas: 321, 541, 532, 761, 752, 743

Scheme: 321, 440, 541, 532, 660, 761, 752 and 743

Cierre central con 2 perfiles 79102







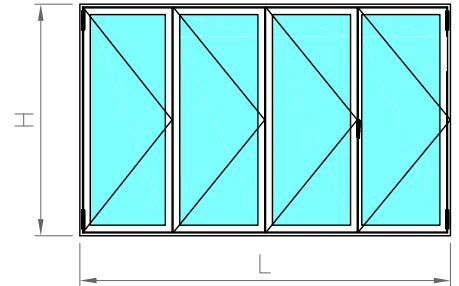













Central closure with 2 profiles 79102

N = número de hojas

N = number of sashes



FÓRMULAS DE CORTES | CUT FORMULAS

Perfiles de marco   Frame Profiles					
Sección   Section	Descripción   Description	Referencia   Cod.	Corte   Cut	Medida   Med.	Cantidad   Qty.
	Marco 77 mm Frame 77 mm	79100		L	2
				H	2
	Hoja 77 mm Sash 77 mm	79101		$[L - 80,2 - (N + 1) \times 12 - 51] / N$	$(N-1) \times 2$
				$[[L - 80,2 - (N - 1) \times 12 - 51] / N] + 51$	2
				H - 90,2	N x 2
	Complemento cerradura 77 mm 77 mm lock complement profile	79102		H - 76,2	2
	Batie Profile support	79103		L - 38,2	2
				H - 38,2	2
				H - 90	1
	Suplemento 14 mm Supplement profile 14 mm	79104		L - 52,2	N x 2
	Complemento para felpudo Profile Complement for felt	79105		L / N (Medida aprox.)	N
	Junquillo recto Straight glazing	(**)		$[L - 92,2 - (N \times 92) - 51] / N$	$(N-1) \times 2$
				$[[L - 92,2 - (N \times 92) - 51] / N] + 51$	2
				H - 210,2	N x 2

(\*\*) Seleccionar junquillos en página de acristalamientos

(\*\*) Select straight glazing on the glazing page

Vidrios   Glasses			
Medidas   Med.			Cantidad   Qty.
Con marco inferior 79100 With bottom frame 79100	$[L - 306,2 - (N - 2) \times 107 - 51] / N$	H - 185	N - 1
	$[[L - 306,2 - (N - 2) \times 107 - 51] / N] + 51$		1

Solución inferior "D"  
Lower solution "D"



## Plegable con MARCO INFERIOR 79100, CIERRE CENTRAL

Folding with LOWER FRAME 79100, CENTRAL CLOSURE

Esquemas: 220, 321, 440, 541, 532, 660, 761, 752, 743 y 880

Scheme: 220, 321, 440, 541, 532, 660, 761, 752, 743 and 880

Cierre central con 1 perfiles 79102







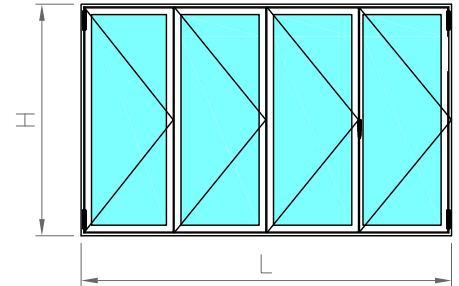













Central closure with 1 profiles 79102

N = número de hojas

N = number of sashes



## FÓRMULAS DE CORTES | CUT FORMULAS

Perfiles de marco   Frame Profiles					
Sección   Section	Descripción   Description	Referencia   Ref.	Corte   Cut	Medida   Med.	Cantidad   Qty.
	Marco 77 mm Frame 77 mm	79100		L	2
				H	2
	Hoja 77 mm Sash 77 mm	79101		$[L - 66,2 - (N + 1) \times 12 - 51] / N$	$(N-1) \times 2$
				$[[L - 66,2 - (N - 1) \times 12 - 51] / N] + 51$	2
				H - 90,2	N x 2
	Complemento cerradura 77 mm 77 mm lock complement profile	79102		H - 76,2	1
	Batiante Profile support	79103		L - 38,2	2
				H - 38,2	2
				H - 90	1
	Suplemento 14 mm Supplement profile 14 mm	79104		L - 52,2	N x 2
	Complemento para felpudo Profile Complement for felt	79105		L / N (Medida aprox.)	N
	Junquillo recto Straight glazing	(**)		$[L - 78,2 - (N \times 92) - 51] / N$	$(N-1) \times 2$
				$[[L - 78,2 - (N \times 92) - 51] / N] + 51$	2
				H - 210,2	N x 2

(\*\*) Seleccionar junquillos en página de acristamientos

(\*\*) Select straight glazing on the glazing page

Vidrios   Glasses			
Medidas   Med.			Cantidad   Qty.
Con marco inferior 79100 With bottom frame 79100	$[L - 292 - (N - 2) \times 107 - 51] / N$	H - 185	N - 1
	$[[L - 292 - (N - 2) \times 107 - 51] / N] + 51$		1

## Plegable con MARCO INFERIOR 79100, CIERRE CENTRAL

Folding with LOWER FRAME 79100, CENTRAL CLOSURE

Esquemas: 220, 321, 440, 541, 532, 660, 761, 752, 743 y 880

Scheme: 220, 321, 440, 541, 532, 660, 761, 752, 743 and 880

Cierre central sin perfiles 79102







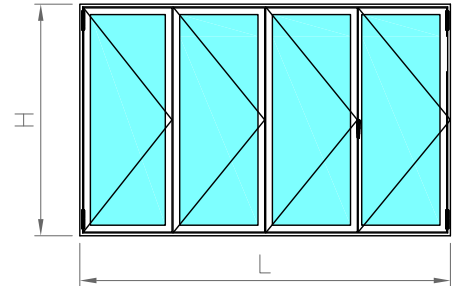











Central closure without profiles 79102

N = número de hojas

N = number of sashes



## FÓRMULAS DE CORTES | CUT FORMULAS

Perfiles de marco   Frame Profiles					
Sección   Section	Descripción   Description	Referencia   Cod.	Corte   Cut	Medida   Med.	Cantidad   Qty.
	Marco 77 mm <i>Frame 77 mm</i>	79100		L	2
				H	2
	Hoja 77 mm <i>Sash 77 mm</i>	79101		$[L - 52,2 - (N + 1) \times 12 - 51] / N$	$(N-1) \times 2$
				$[[L - 52,2 - (N - 1) \times 12 - 51] / N] + 51$	2
				H - 90,2	N x 2
	Batie <i>Profile support</i>	79103		L - 38,2	2
				H - 38,2	2
				H - 90	1
	Suplemento 14 mm <i>Supplement profile 14 mm</i>	79104		L - 52,2	N x 2
	Complemento para felpudo <i>Profile Complement for felt</i>	79105		L / N (Medida aprox.)	N
	Junquillo recto <i>Straight glazing</i>	(**)		$[L - 64,2 - (N \times 92) - 51] / N$	$(N-1) \times 2$
				$[[L - 64,2 - (N \times 92) - 51] / N] + 51$	2
				H - 210,2	N x 2

(\*\*) Seleccionar junquillos en página de acristalamientos

(\*\*) Select straight glazing on the glazing page

Vidrios   Glasses			
Medidas   Med.			Cantidad   Qty.
Con marco inferior 79100 <i>With bottom frame 79100</i>	$[L - 171,2 - (N - 2) \times 107 - 51] / N$	H - 185	N - 1
	$[[L - 171,2 - (N - 2) \times 107 - 51] / N] + 51$		1

Plegable con MARCO INFERIOR 79100, CIERRE CENTRAL

Folding with LOWER FRAME 79100, CENTRAL CLOSURE

Esquemas: 211, 431, 633, 651, 871 y 853

Scheme: 211, 431, 633, 651, 871 and 853

Cierre central con 2 perfiles 79102







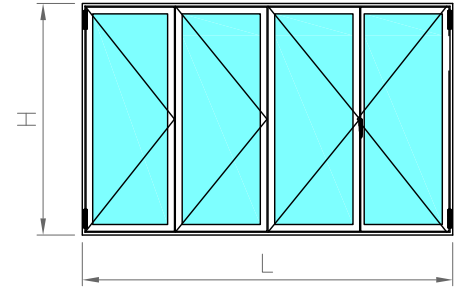











Central closure with 2 profiles 79102

N = número de hojas

N = number of sashes



FÓRMULAS DE CORTES | CUT FORMULAS

Perfiles de marco   Frame Profiles					
Sección   Section	Descripción   Description	Referencia   Cod.	Corte   Cut	Medida   Med.	Cantidad   Qty.
	Marco 77 mm <i>Frame 77 mm</i>	79100		L	2
				H	2
	Hoja 77 mm <i>Sash 77 mm</i>	79101		$[L - 80,2 - (N + 1) \times 12] / N$	N x 2
				H - 90,2	N x 2
	Complemento cerradura 77 mm <i>77 mm lock complement profile</i>	79102		H - 76,2	2
	Batiente <i>Profile support</i>	79103		L - 38,2	2
				H - 38,2	2
				H - 90	1
	Suplemento 14 mm <i>Supplement profile 14 mm</i>	79104		L - 52,2	N x 2
	Complemento para felpudo <i>Profile Complement for felt</i>	79105		L / N (Medida aprox.)	N
	Junquillo recto <i>Straight glazing</i>	(**)		$[L - 92,2 - (N \times 92)] / N$	N x 2
				H - 210,2	N x 2

(\*\*) Seleccionar junquillos en página de acristalamientos

(\*\*) Select straight glazing on the glazing page

Vidrios   Glasses			
Medidas   Med.			Cantidad   Qty.
Con marco inferior 79100 <i>With bottom frame 79100</i>	$[L - 306,2 - (N - 2) \times 107] / N$	H - 185	N

**Plegable con MARCO INFERIOR 79100, CIERRE CENTRAL**

*Folding with LOWER FRAME 79100, CENTRAL CLOSURE*

Esquemas: 211, 330, 431, 550, 633, 651, 770, 871 y 853

*Scheme: 211, 330, 431, 550, 633, 651, 770, 871 and 853*

Cierre central con 1 perfiles 79102







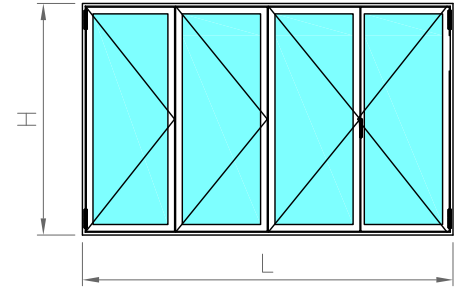











*Central closure with 1 profiles 79102*

N = número de hojas

*N = number of sashes*



**FÓRMULAS DE CORTES | CUT FORMULAS**

Perfiles de marco   Frame Profiles					
Sección   Section	Descripción   Description	Referencia   Cod.	Corte   Cut	Medida   Med.	Cantidad   Qty.
	Marco 77 mm <i>Frame 77 mm</i>	79100		L	2
				H	2
	Hoja 77 mm <i>Sash 77 mm</i>	79101		$[L - 80,2 - (N + 1) \times 12] / N$	N x 2
				H - 90,2	N x 2
	Complemento cerradura 77 mm <i>77 mm lock complement profile</i>	79102		H - 76,2	1
	Batiente <i>Profile support</i>	79103		L - 38,2	2
				H - 38,2	2
				H - 90	1
	Suplemento 14 mm <i>Supplement profile 14 mm</i>	79104		L - 52,2	N x 2
	Complemento para felpudo <i>Profile Complement for felt</i>	79105		L / N (Medida aprox.)	N
	Junquillo recto <i>Straight glazing</i>	(**)		$[L - 78,2 - (N \times 92)] / N$	N x 2
				H - 210,2	N x 2

(\*\*) Seleccionar junquillos en página de acristalamientos

*(\*\*) Select straight glazing on the glazing page*

Vidrios   Glasses			
Medidas   Med.			Cantidad   Qty.
Con marco inferior 79100 <i>With bottom frame 79100</i>	$[L - 292 - (N - 2) \times 107] / N$	H - 185	N

**Solución inferior "D"**  
*Lower solution "D"*

Plegable con MARCO INFERIOR 79100, CIERRE CENTRAL

Folding with LOWER FRAME 79100, CENTRAL CLOSURE

Esquemas: 211, 330, 431, 550, 633, 651, 770, 871 y 853

Scheme: 211, 330, 431, 550, 633, 651, 770, 871 and 853

Cierre central sin perfiles 79102







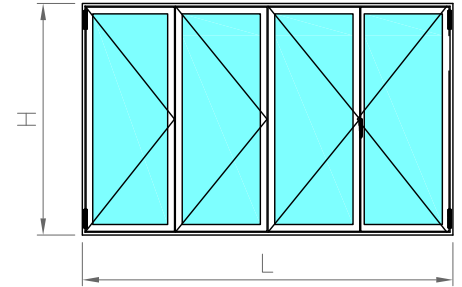









Central closure without profiles 79102

N = número de hojas

N = number of sashes



FÓRMULAS DE CORTES | CUT FORMULAS

Perfiles de marco   Frame Profiles					
Sección   Section	Descripción   Description	Referencia   Cod.	Corte   Cut	Medida   Med.	Cantidad   Qty.
	Marco 77 mm <i>Frame 77 mm</i>	79100		L	2
				H	2
	Hoja 77 mm <i>Sash 77 mm</i>	79101		$[L - 80,2 - (N + 1) \times 12] / N$	N x 2
				H - 90,2	N x 2
	Batiente <i>Profile support</i>	79103		L - 38,2	2
				H - 38,2	2
				H - 90	1
	Suplemento 14 mm <i>Supplement profile 14 mm</i>	79104		L - 52,2	N x 2
	Complemento para felpudo <i>Profile Complement for felt</i>	79105		L / N (Medida aprox.)	N
	Junquillo recto <i>Straight glazing</i>	(**)		$[L - 64,2 - (N \times 92)] / N$	N x 2
				H - 210,2	N x 2

(\*\*) Seleccionar junquillos en página de acristalamientos

(\*\*) Select straight glazing on the glazing page

Vidrios   Glasses			
Medidas   Med.			Cantidad   Qty.
Con marco inferior 79100 <i>With bottom frame 79100</i>	$[L - 171,2 - (N - 2) \times 107] / N$	H - 185	N

Solución inferior "D"  
Lower solution "D"

**Sección vertical con marco inferior 79100**  
*Vertical section with bottom frame 79100*

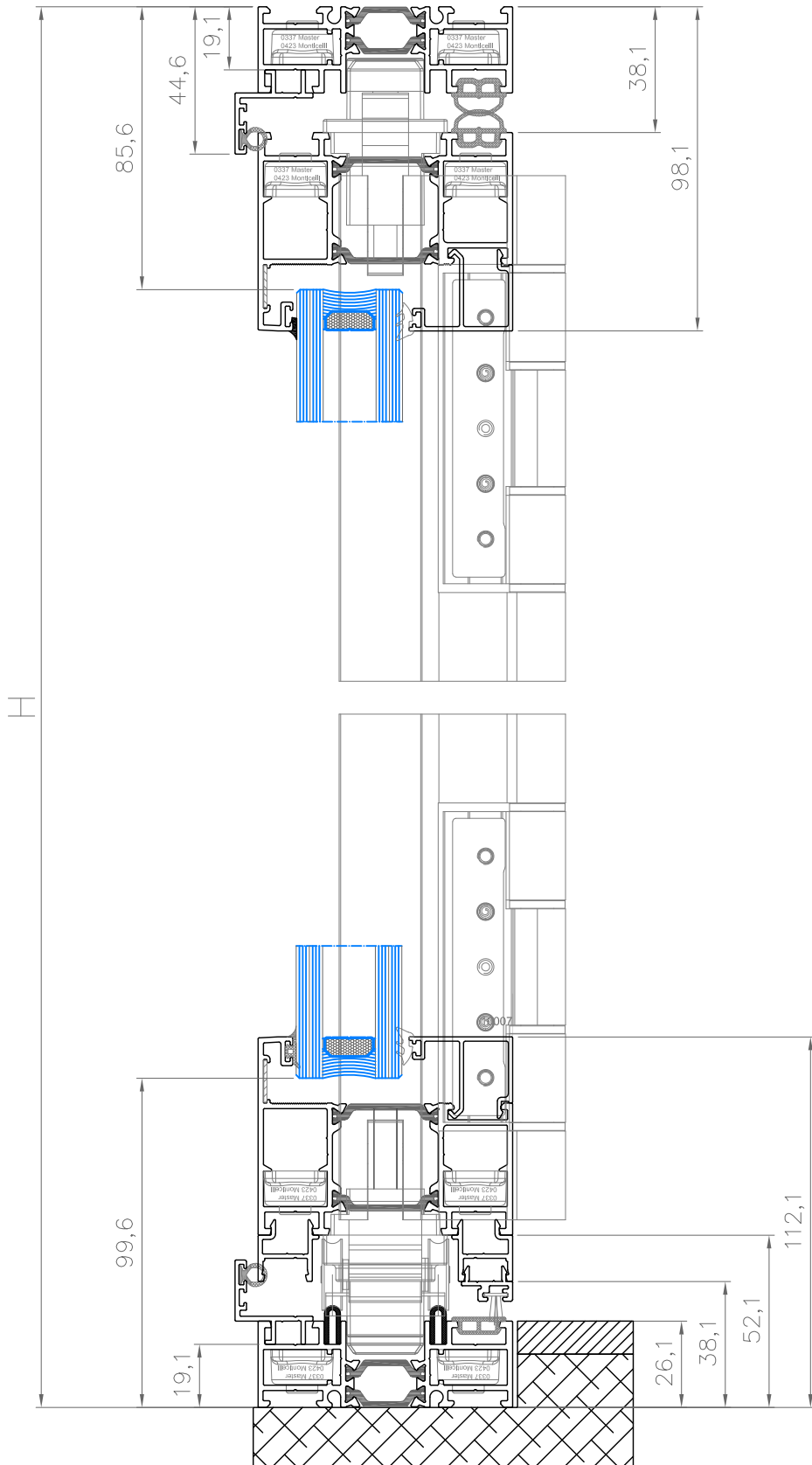

**Solución inferior "F"**  
*Lower solution "F"*

Plegable con MARCO INFERIOR 79100, CIERRE CENTRAL

Folding with LOWER FRAME 79100, CENTRAL CLOSURE

Esquemas: 422, 642, 844 y 862

Scheme: 422, 642, 844 y 862

Cierre central con 2 perfiles 79102







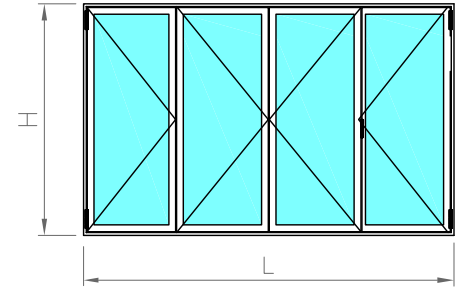















Central closure with 2 profiles 79102

N = número de hojas

N = number of sashes



FÓRMULAS DE CORTES | CUT FORMULAS

Perfiles de marco   Frame Profiles					
Sección   Section	Descripción   Description	Referencia   Cod.	Corte   Cut	Medida   Med.	Cantidad   Qty.
	Marco 77 mm <i>Frame 77 mm</i>	79100		L	2
				H	2
	Hoja 77 mm <i>Sash 77 mm</i>	79101		$[L - 80,2 - (N + 1) \times 12 - 102] / N$	(N-2) x 2
				$[[L - 80,2 - (N - 1) \times 12 - 102] / N] + 51$	4
				H - 90,2	N x 2
	Complemento cerradura 77 mm <i>77 mm lock complement profile</i>	79102		H - 76,2	2
	Batiente <i>Profile support</i>	79103		L - 38,2	1
				H - 59,2	1
				H - 59,2	1
	Suplemento 14 mm <i>Supplement profile 14 mm</i>	79104		$[L - 80,2 - (N + 1) \times 12 - 102] / N$	(N-2) x 2
				$[[L - 80,2 - (N - 1) \times 12 - 102] / N] + 51$	4
	Complemento para felpudo <i>Profile Complement for felt</i>	79105		L / N (Medida aprox.)	N
	Junquillo recto <i>Straight glazing</i>	(**)		$[L - 92,2 - (N \times 92) - 102] / N$	(N-2) x 2
				$[[L - 92,2 - (N \times 92) - 102] / N] + 51$	4
				H - 210,2	N x 2

(\*\*) Seleccionar junquillos en página de acristalamientos

(\*\*) Select straight glazing on the glazing page

Vidrios   Glasses			
Medidas   Med.			Cantidad   Qty.
Con marco inferior 79100 <i>With bottom frame 79100</i>	$[L - 306,2 - (N - 2) \times 107 - 102] / N$	H - 185	N - 2
	$[[L - 306,2 - (N - 2) \times 107 - 102] / N] + 51$		2

Plegable con MARCO INFERIOR 79100, CIERRE CENTRAL

Folding with LOWER FRAME 79100, CENTRAL CLOSURE

Esquemas: 422, 642, 844 y 862

Scheme: 422, 642, 844 y 862

Cierre central con 1 perfiles 79102







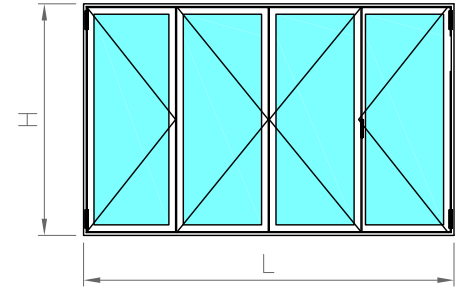















Central closure with 1 profiles 79102

N = número de hojas

N = number of sashes



FÓRMULAS DE CORTES | CUT FORMULAS

Perfiles de marco   Frame Profiles					
Sección   Section	Descripción   Description	Referencia   Cod.	Corte   Cut	Medida   Med.	Cantidad   Qty.
	Marco 77 mm <i>Frame 77 mm</i>	79100		L	2
				H	2
	Hoja 77 mm <i>Sash 77 mm</i>	79101		$[L - 66,2 - (N + 1) \times 12 - 102] / N$	$(N - 2) \times 2$
				$[[L - 66,2 - (N - 1) \times 12 - 102] / N] + 51$	4
				H - 90,2	N x 2
	Complemento cerradura 77 mm <i>77 mm lock complement profile</i>	79102		H - 76,2	1
	Batiente <i>Profile support</i>	79103		L - 38,2	1
				H - 59,2	1
				H - 59,2	1
	Suplemento 14 mm <i>Supplement profile 14 mm</i>	79104		$[L - 66,2 - (N + 1) \times 12 - 102] / N$	$(N - 2) \times 2$
				$[[L - 66,2 - (N - 1) \times 12 - 102] / N] + 51$	4
	Complemento para felpudo <i>Profile Complement for felt</i>	79105		L / N (Medida aprox.)	N
	Junquillo recto <i>Straight glazing</i>	(**)		$[L - 78,2 - (N \times 92) - 102] / N$	N x 2
				$[[L - 78,2 - (N \times 92) - 102] / N] + 51$	4
				H - 210,2	N x 2

(\*\*) Seleccionar junquillos en página de acristamientos

(\*\*) Select straight glazing on the glazing page

Vidrios   Glasses			
Medidas   Med.			Cantidad   Qty.
Con marco inferior 79100 <i>With bottom frame 79100</i>	$[L - 292 - (N - 2) \times 107 - 102] / N$	H - 185	N - 2
	$[[L - 292 - (N - 2) \times 107 - 102] / N] + 51$		2



Plegable con MARCO INFERIOR 79100, CIERRE CENTRAL

Folding with LOWER FRAME 79100, CENTRAL CLOSURE

Esquemas: 422, 642, 844 y 862

Scheme: 422, 642, 844 y 862

Cierre central sin perfiles 79102







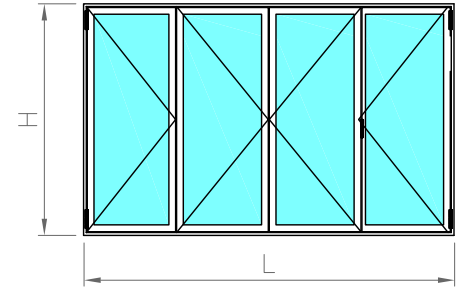













Central closure without profiles 79102

N = número de hojas

N = number of sashes



FÓRMULAS DE CORTES | CUT FORMULAS

Perfiles de marco   Frame Profiles					
Sección   Section	Descripción   Description	Referencia   Cod.	Corte   Cut	Medida   Med.	Cantidad   Qty.
	Marco 77 mm <i>Frame 77 mm</i>	79100		L	2
				H	2
	Hoja 77 mm <i>Sash 77 mm</i>	79101		$[L - 52,2 - (N + 1) \times 12 - 102] / N$	$(N-2) \times 2$
				$[[L - 52,2 - (N - 1) \times 12 - 102] / N] + 51$	4
				H - 90,2	N x 2
	Batiante <i>Profile support</i>	79103		L - 38,2	1
				H - 59,2	1
				H - 59,2	1
	Suplemento 14 mm <i>Supplement profile 14 mm</i>	79104		$[L - 52,2 - (N + 1) \times 12 - 102] / N$	$(N-2) \times 2$
				$[[L - 52,2 - (N - 1) \times 12 - 102] / N] + 51$	4
	Complemento para felpudo <i>Profile Complement for felt</i>	79105		L / N (Medida aprox.)	N
	Junquillo recto <i>Straight glazing</i>	(**)		$[L - 64,2 - (N \times 92) - 102] / N$	N x 2
				$[[L - 64,2 - (N \times 92) - 102] / N] + 51$	4
				H - 210,2	N x 2

(\*\*) Seleccionar junquillos en página de acristalamientos

(\*\*) Select straight glazing on the glazing page

Vidrios   Glasses			
Medidas   Med.			Cantidad   Qty.
Con marco inferior 79100 <i>With bottom frame 79100</i>	$[L - 171,2 - (N - 2) \times 107 - 102] / N$	H - 185	N - 2
	$[[L - 171,2 - (N - 2) \times 107 - 102] / N] + 51$		2

Plegable con MARCO INFERIOR 79100, CIERRE CENTRAL

Folding with LOWER FRAME 79100, CENTRAL CLOSURE

Esquemas: 321, 541, 532, 761, 752 y 743

Scheme: 321, 541, 532, 761, 752 y 743

Cierre central con 2 perfiles 79102







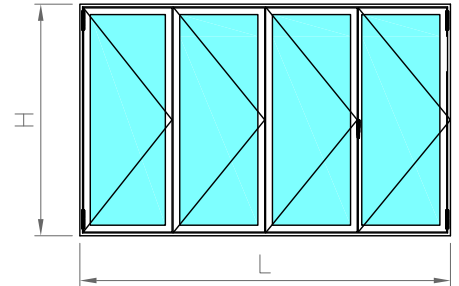















Central closure with 2 profiles 79102

N = número de hojas

N = number of sashes



FÓRMULAS DE CORTES | CUT FORMULAS

Perfiles de marco   Frame Profiles					
Sección   Section	Descripción   Description	Referencia   Cod.	Corte   Cut	Medida   Med.	Cantidad   Qty.
	Marco 77 mm <i>Frame 77 mm</i>	79100		L	2
				H	2
	Hoja 77 mm <i>Sash 77 mm</i>	79101		$[L - 80,2 - (N + 1) \times 12 - 51] / N$	$(N-1) \times 2$
				$[[L - 80,2 - (N - 1) \times 12 - 51] / N] + 51$	2
				H - 90,2	N x 2
	Complemento cerradura 77 mm <i>77 mm lock complement profile</i>	79102		H - 76,2	2
	Batiente <i>Profile support</i>	79103		L - 38,2	2
				H - 38,2	2
				H - 97	1
	Suplemento 14 mm <i>Supplement profile 14 mm</i>	79104		$[L - 80,2 - (N + 1) \times 12 - 51] / N$	$(N-1) \times 2$
				$[[L - 80,2 - (N - 1) \times 12 - 51] / N] + 51$	2
	Complemento para felpudo <i>Profile Complement for felt</i>	79105		L / N (Medida aprox.)	N
	Junquillo recto <i>Straight glazing</i>	(**)		$[L - 92,2 - (N \times 92) - 51] / N$	$(N-1) \times 2$
				$[[L - 92,2 - (N \times 92) - 51] / N] + 51$	2
				H - 210,2	N x 2

(\*\*) Seleccionar junquillos en página de acristalamientos

(\*\*) Select straight glazing on the glazing page

Vidrios   Glasses			
Medidas   Med.			Cantidad   Qty.
Con marco inferior 79100 <i>With bottom frame 79100</i>	$[L - 306,2 - (N - 2) \times 107 - 51] / N$	H - 185	N - 1
	$[[L - 306,2 - (N - 2) \times 107 - 51] / N] + 51$		1

Plegable con MARCO INFERIOR 79100, CIERRE CENTRAL

Folding with LOWER FRAME 79100, CENTRAL CLOSURE

Esquemas: 220, 321, 440, 541, 532, 660, 761, 752, 743 y 880

Scheme: 220, 321, 440, 541, 532, 660, 761, 752, 743 and 880

Cierre central con 1 perfiles 79102







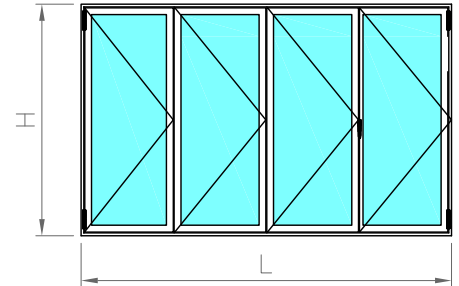















Central closure with 1 profiles 79102

N = número de hojas

N = number of sashes



FÓRMULAS DE CORTES | CUT FORMULAS

Perfiles de marco   Frame Profiles					
Sección   Section	Descripción   Description	Referencia   Cod.	Corte   Cut	Medida   Med.	Cantidad   Qty.
	Marco 77 mm <i>Frame 77 mm</i>	79100		L	2
				H	2
	Hoja 77 mm <i>Sash 77 mm</i>	79101		$[L - 66,2 - (N + 1) \times 12 - 51] / N$	$(N-1) \times 2$
				$[[L - 66,2 - (N - 1) \times 12 - 51] / N] + 51$	2
				H - 90,2	N x 2
	Complemento cerradura 77 mm <i>77 mm lock complement profile</i>	79102		H - 76,2	1
	Batiente <i>Profile support</i>	79103		H - 38,2	2
				L - 38,2	2
				H - 97	1
	Suplemento 14 mm <i>Supplement profile 14 mm</i>	79104		$[L - 66,2 - (N + 1) \times 12 - 51] / N$	$(N-1) \times 2$
				$[[L - 66,2 - (N - 1) \times 12 - 51] / N] + 51$	2
	Complemento para felpudo <i>Profile Complement for felt</i>	79105		L / N (Medida aprox.)	N
	Junquillo recto <i>Straight glazing</i>	(**)		$[L - 78,2 - (N \times 92) - 51] / N$	$(N-1) \times 2$
				$[[L - 78,2 - (N \times 92) - 51] / N] + 51$	2
				H - 210,2	N x 2

(\*\*) Seleccionar junquillos en página de acristalamientos

(\*\*) Select straight glazing on the glazing page

Vidrios   Glasses			
Medidas   Med.			Cantidad   Qty.
Con marco inferior 79100 <i>With bottom frame 79100</i>	$[L - 292 - (N - 2) \times 107 - 51] / N$	H - 185	N - 1
	$[[L - 292 - (N - 2) \times 107 - 51] / N] + 51$		1

Plegable con MARCO INFERIOR 79100, CIERRE CENTRAL

Folding with LOWER FRAME 79100, CENTRAL CLOSURE

Esquemas: 220, 321, 440, 541, 532, 660, 761, 752, 743 y 880

Scheme: 220, 321, 440, 541, 532, 660, 761, 752, 743 and 880

Cierre central sin perfiles 79102







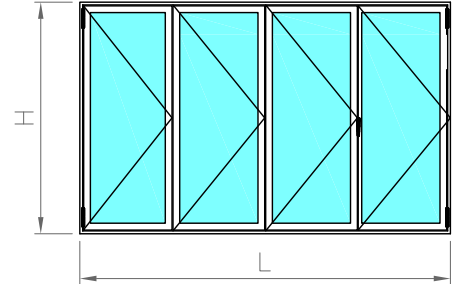













Central closure without profiles 79102

N = número de hojas

N = number of sashes



FÓRMULAS DE CORTES | CUT FORMULAS

Perfiles de marco   Frame Profiles					
Sección   Section	Descripción   Description	Referencia   Cod.	Corte   Cut	Medida   Med.	Cantidad   Qty.
	Marco 77 mm <i>Frame 77 mm</i>	79100		L	2
				H	2
	Hoja 77 mm <i>Sash 77 mm</i>	79101		$[L - 52,2 - (N + 1) \times 12 - 51] / N$	$(N-1) \times 2$
				$[[L - 52,2 - (N - 1) \times 12 - 51] / N] + 51$	2
				H - 90,2	N x 2
	Batiante <i>Profile support</i>	79103		L - 38,2	2
				H - 38,2	2
				H - 97	1
	Suplemento 14 mm <i>Supplement profile 14 mm</i>	79104		$[L - 52,2 - (N + 1) \times 12 - 51] / N$	$(N-1) \times 2$
				$[[L - 52,2 - (N - 1) \times 12 - 51] / N] + 51$	2
	Complemento para felpudo <i>Profile Complement for felt</i>	79105		L / N (Medida aprox.)	N
	Junquillo recto <i>Straight glazing</i>	(**)		$[L - 64,2 - (N \times 92) - 51] / N$	$(N-1) \times 2$
				$[[L - 64,2 - (N \times 92) - 51] / N] + 51$	2
				H - 210,2	N x 2

(\*\*) Seleccionar junquillos en página de acristamientos

(\*\*) Select straight glazing on the glazing page

Vidrios   Glasses			
Medidas   Med.			Cantidad   Qty.
Con marco inferior 79100 <i>With bottom frame 79100</i>	$[L - 171,2 - (N - 2) \times 107 - 51] / N$	H - 185	N - 1
	$[[L - 171,2 - (N - 2) \times 107 - 51] / N] + 51$		1

## Plegable con MARCO INFERIOR 79100, CIERRE CENTRAL

Folding with LOWER FRAME 79100, CENTRAL CLOSURE

Esquemas: 211, 431, 633, 651, 871 y 853

Scheme: 211, 431, 633, 651, 871 and 853

Cierre central con 2 perfiles 79102







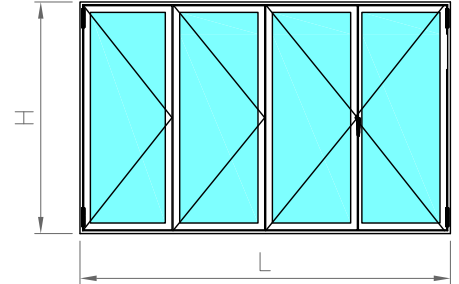











Central closure with 2 profiles 79102

N = número de hojas

N = number of sashes



## FÓRMULAS DE CORTES | CUT FORMULAS

Perfiles de marco   Frame Profiles					
Sección   Section	Descripción   Description	Referencia   Cod.	Corte   Cut	Medida   Med.	Cantidad   Qty.
	Marco 77 mm <i>Frame 77 mm</i>	79100		L	2
				H	2
	Hoja 77 mm <i>Sash 77 mm</i>	79101		$[L - 80,2 - (N + 1) \times 12] / N$	N x 2
				H - 90,2	N x 2
	Complemento cerradura 77 mm <i>77 mm lock complement profile</i>	79102		H - 76,2	2
	Batiente <i>Profile support</i>	79103		L - 38,2	2
				H - 38,2	2
				H - 90	1
	Suplemento 14 mm <i>Supplement profile 14 mm</i>	79104		$[L - 80,2 - (N + 1) \times 12] / N$	N x 2
	Complemento para felpudo <i>Profile Complement for felt</i>	79105		L / N (Medida aprox.)	N
	Junquillo recto <i>Straight glazing</i>	(**)		$[L - 92,2 - (N \times 92)] / N$	N x 2
				H - 210,2	N x 2

(\*\*) Seleccionar junquillos en página de acristamientos

(\*\*) Select straight glazing on the glazing page

Vidrios   Glasses			
Medidas   Med.			Cantidad   Qty.
Con marco inferior 79100 <i>With bottom frame 79100</i>	$[L - 306,2 - (N - 2) \times 107] / N$	H - 185	N

## Plegable con MARCO INFERIOR 79100, CIERRE CENTRAL

*Folding with LOWER FRAME 79100, CENTRAL CLOSURE*

Esquemas: 211, 330, 431, 550, 633, 651, 770, 871 y 853

*Scheme: 211, 330, 431, 550, 633, 651, 770, 871 and 853*

Cierre central con 1 perfil 79102







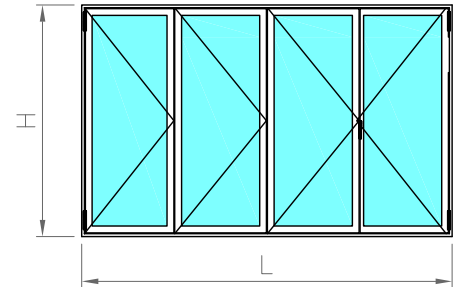











*Central closure with 1 profile 79102*

N = número de hojas

*N = number of sashes*



## FÓRMULAS DE CORTES | CUT FORMULAS

Perfiles de marco   Frame Profiles					
Sección   Section	Descripción   Description	Referencia   Cod.	Corte   Cut	Medida   Med.	Cantidad   Qty.
	Marco 77 mm <i>Frame 77 mm</i>	79100		L	2
				H	2
	Hoja 77 mm <i>Sash 77 mm</i>	79101		$[L - 66,2 - (N + 1) \times 12] / N$	N x 2
				H - 90,2	N x 2
	Complemento cerradura 77 mm <i>77 mm lock complement profile</i>	79102		H - 76,2	1
	Batiente <i>Profile support</i>	79103		L - 38,2	2
				H - 38,2	2
				H - 90	1
	Suplemento 14 mm <i>Supplement profile 14 mm</i>	79104		$[L - 66,2 - (N + 1) \times 12] / N$	N x 2
	Complemento para felpudo <i>Profile Complement for felt</i>	79105		L / N (Medida aprox.)	N
	Junquillo recto <i>Straight glazing</i>	(**)		$[L - 64,2 - (N \times 92)] / N$	N x 2
				H - 210,2	N x 2

(\*\*) Seleccionar junquillos en página de acristamientos

*(\*\*) Select straight glazing on the glazing page*

Vidrios   Glasses			
Medidas   Med.			Cantidad   Qty.
Con marco inferior 79100 <i>With bottom frame 79100</i>	$[L - 185,2 - (N - 1) \times 107] / N$	H - 185	N

## Plegable con MARCO INFERIOR 79100, CIERRE LATERAL

*Folding with LOWER FRAME 79100, SIDE CLOSURE*

Esquemas: 211, 330, 431, 550, 633, 651, 770, 871 y 853

*Scheme: 211, 330, 431, 550, 633, 651, 770, 871 and 853*

Cierre central sin perfiles 79102







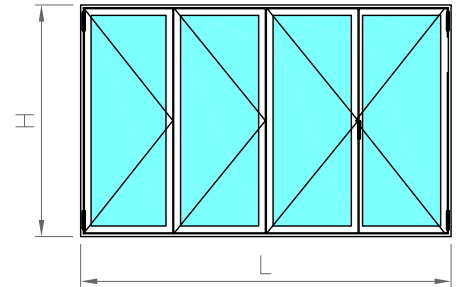









*Central closure without profiles 79102*

N = número de hojas

*N = number of sashes*



## FÓRMULAS DE CORTES | CUT FORMULAS

Perfiles de marco   Frame Profiles					
Sección   Section	Descripción   Description	Referencia   Cod.	Corte   Cut	Medida   Med.	Cantidad   Qty.
	Marco 77 mm <i>Frame 77 mm</i>	79100		L	2
				H	2
	Hoja 77 mm <i>Sash 77 mm</i>	79101		$[L - 52,2 - (N + 1) \times 12] / N$	N x 2
				H - 90,2	N x 2
	Batiente <i>Profile support</i>	79103		L - 38,2	2
				H - 38,2	2
				H - 90	1
	Suplemento 14 mm <i>Supplement profile 14 mm</i>	79104		$[L - 52,2 - (N + 1) \times 12] / N$	N x 2
	Complemento para felpudo <i>Profile Complement for felt</i>	79105		L / N (Medida aprox.)	N
	Junquillo recto <i>Straight glazing</i>	(**)		$[L - 78,2 - (N \times 92)] / N$	N x 2
				H - 210,2	N x 2

(\*\*) Seleccionar junquillos en página de acristalamientos

*(\*\*) Select straight glazing on the glazing page*

Vidrios   Glasses			
Medidas   Med.			Cantidad   Qty.
Con marco inferior 79100 <i>With bottom frame 79100</i>	$[L - 171,2 - (N - 1) \times 107] / N$	H - 185	N

**Solución inferior "F"**  
*Lower solution "F"*

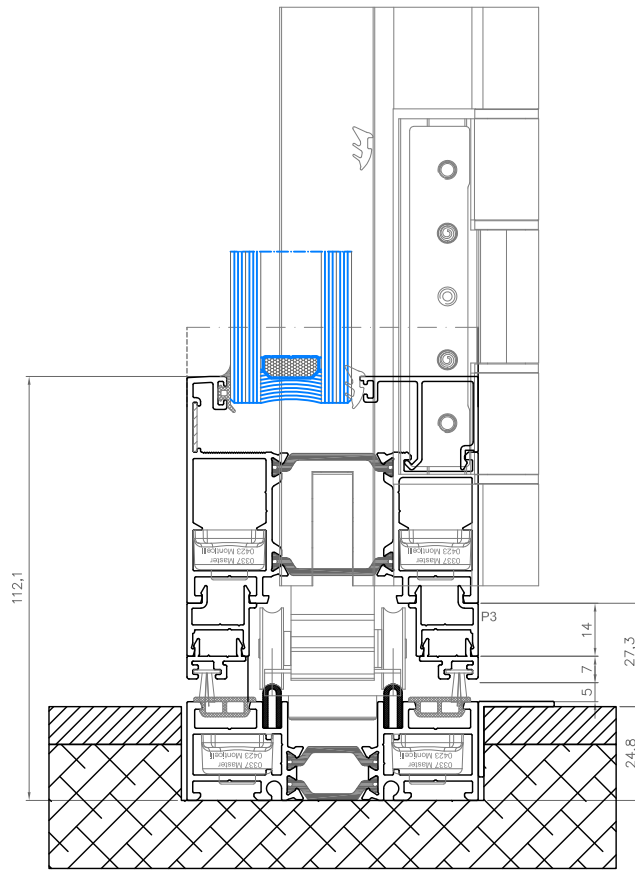
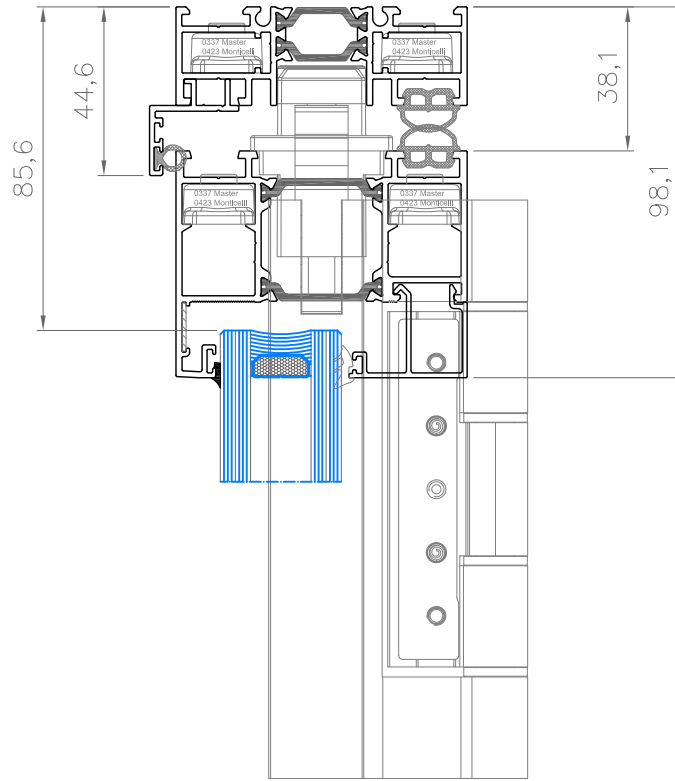

qsline.es



Plegable con MARCO INFERIOR 79100, CIERRE CENTRAL

Folding with LOWER FRAME 79100, CENTRAL CLOSURE

Esquemas: 422, 642, 844 y 862

Scheme: 422, 642, 844 y 862

Cierre central con 2 perfiles 79102







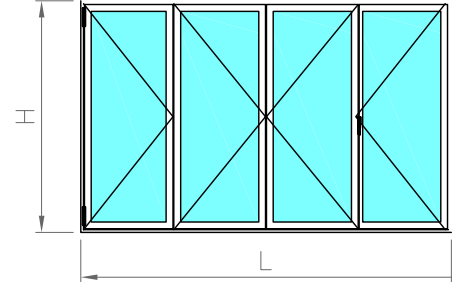















Central closure with 2 profiles 79102

N = número de hojas

N = number of sashes



FÓRMULAS DE CORTES | CUT FORMULAS

Perfiles de marco   Frame Profiles					
Sección   Section	Descripción   Description	Referencia   Ref.	Corte   Cut	Medida   Med.	Cantidad   Qty.
	Marco 77 mm <i>Frame 77 mm</i>	79100		L	2
				H	2
	Hoja 77 mm <i>Sash 77 mm</i>	79101		$[L - 80,2 - (N + 1) \times 12 - 102] / N$	$(N-2) \times 2$
				$[[L - 80,2 - (N - 1) \times 12 - 102] / N] + 51$	4
				H - 90,2	N x 2
	Complemento cerradura 77 mm <i>77 mm lock complement profile</i>	79102		H - 76,2	2
	Batiente <i>Profile support</i>	79103		L - 38,2	2
				H - 59,2	1
				H - 59,2	1
	Suplemento 14 mm <i>Supplement profile 14 mm</i>	79104		$[L - 80,2 - (N + 1) \times 12 - 102] / N$	$(N-2) \times 2$
				$[[L - 80,2 - (N - 1) \times 12 - 102] / N] + 51$	4
	Complemento para felpudo <i>Profile Complement for felt</i>	79105		L / N (Medida aprox.)	N x 2
	Junquillo recto <i>Straight glazing</i>	(**)		$[L - 92,2 - (N \times 92) - 102] / N$	$(N-2) \times 2$
				$[[L - 92,2 - (N \times 92) - 102] / N] + 51$	4
				H - 210,2	N x 2

(\*\*) Seleccionar junquillos en página de acristalamientos

(\*\*) Select straight glazing on the glazing page

Vidrios   Glasses			
Medidas   Med.			Cantidad   Qty.
Con marco inferior 79100 <i>With bottom frame 79100</i>	$[L - 306,2 - (N - 2) \times 107 - 102] / N$	H - 185	N - 2
	$[[L - 306,2 - (N - 2) \times 107 - 102] / N] + 51$		2

Plegable con MARCO INFERIOR 79100, CIERRE CENTRAL

Folding with LOWER FRAME 79100, CENTRAL CLOSURE

Esquemas: 422, 642, 844 y 862

Scheme: 422, 642, 844 y 862

Cierre central con 1 perfiles 79102







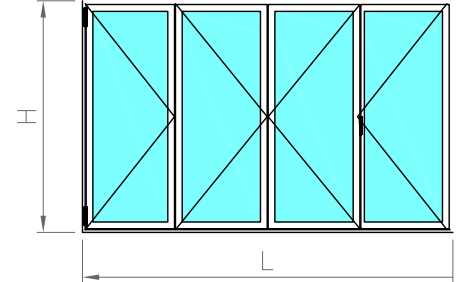















Central closure with 1 profiles 79102

N = número de hojas

N = number of sashes



FÓRMULAS DE CORTES | CUT FORMULAS

Perfiles de marco   Frame Profiles					
Sección   Section	Descripción   Description	Referencia   Cod.	Corte   Cut	Medida   Med.	Cantidad   Qty.
	Marco 77 mm <i>Frame 77 mm</i>	79100		L	2
				H	2
	Hoja 77 mm <i>Sash 77 mm</i>	79101		$[L - 66,2 - (N + 1) \times 12 - 102] / N$	(N-2) x 2
				$[[L - 66,2 - (N - 1) \times 12 - 102] / N] + 51$	4
				H - 90,2	N x 2
	Complemento cerradura 77 mm <i>77 mm lock complement profile</i>	79102		H - 76,2	1
	Batiente <i>Profile support</i>	79103		L - 38,2	1
				H - 59,2	1
				H - 59,2	1
	Suplemento 14 mm <i>Supplement profile 14 mm</i>	79104		$[L - 66,2 - (N + 1) \times 12 - 102] / N$	(N-2) x 2
				$[[L - 66,2 - (N - 1) \times 12 - 102] / N] + 51$	4
	Complemento para felpudo <i>Profile Complement for felt</i>	79105		L / N (Medida aprox.)	N x 2
	Junquillo recto <i>Straight glazing</i>	(**)		$[L - 78,2 - (N \times 92) - 102] / N$	(N-2) x 2
				$[[L - 78,2 - (N \times 92) - 102] / N] + 51$	4
				H - 210,2	N x 2

(\*\*) Seleccionar junquillos en página de acristalamientos

(\*\*) Select straight glazing on the glazing page

Vidrios   Glasses			
Medidas   Med.			Cantidad   Qty.
Con marco inferior 79100 <i>With bottom frame 79100</i>	$[L - 292 - (N - 2) \times 107 - 102] / N$	H - 185	N - 2
	$[[L - 292 - (N - 2) \times 107 - 102] / N] + 51$		2

Plegable con MARCO INFERIOR 79100, CIERRE CENTRAL

Folding with LOWER FRAME 79100, CENTRAL CLOSURE

Esquemas: 422, 642, 844 y 862

Scheme: 422, 642, 844 y 862

Cierre central sin perfiles 79102







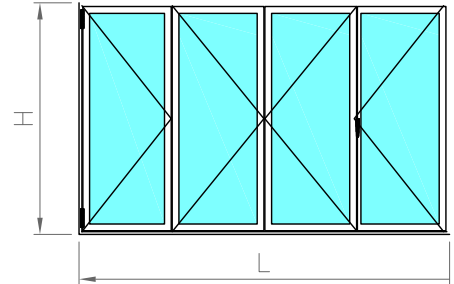













Central closure without profiles 79102

N = número de hojas

N = number of sashes



FÓRMULAS DE CORTES | CUT FORMULAS

Perfiles de marco   Frame Profiles					
Sección   Section	Descripción   Description	Referencia   Cod.	Corte   Cut	Medida   Med.	Cantidad   Qty.
	Marco 77 mm Frame 77 mm	79100		L	2
				H	2
	Hoja 77 mm Sash 77 mm	79101		$[L - 52,2 - (N + 1) \times 12 - 102] / N$	$(N-2) \times 2$
				$[[L - 52,2 - (N - 1) \times 12 - 102] / N] + 51$	4
				H - 90,2	N x 2
	Batiente Profile support	79103		L - 38,2	1
				H - 59,2	1
				H - 59,2	1
	Suplemento 14 mm Supplement profile 14 mm	79104		$[L - 52,2 - (N + 1) \times 12 - 102] / N$	$(N-2) \times 2$
				$[[L - 52,2 - (N - 1) \times 12 - 102] / N] + 51$	4
	Complemento para felpudo Profile Complement for felt	79105		L / N (Medida aprox.)	N x 2
	Junquillo recto Straight glazing	(**)		$[L - 64,2 - (N \times 92) - 102] / N$	$(N-2) \times 2$
				$[[L - 64,2 - (N \times 92) - 102] / N] + 51$	4
				H - 210,2	N x 2

(\*\*) Seleccionar junquillos en página de acristamientos

(\*\*) Select straight glazing on the glazing page

Vidrios   Glasses			
Medidas   Med.			Cantidad   Qty.
Con marco inferior 79100 With bottom frame 79100	$[L - 171,2 - (N - 2) \times 107 - 102] / N$	H - 185	N - 2
	$[[L - 171,2 - (N - 2) \times 107 - 102] / N] + 51$		2

**Plegable con MARCO INFERIOR 79100, CIERRE CENTRAL**

*Folding with LOWER FRAME 79100, CENTRAL CLOSURE*

Esquemas: 321, 541, 532, 761, 752 y 743

*Scheme: 321, 541, 532, 761, 752 and 743*

Cierre central con 2 perfiles 79102







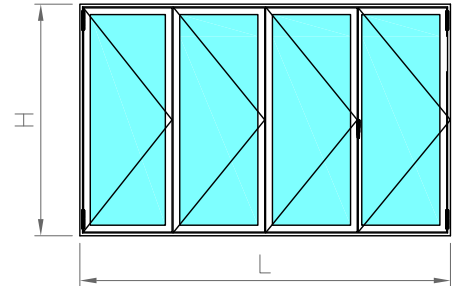















*Central closure with 2 profiles 79102*

N = número de hojas

*N = number of sashes*



**FÓRMULAS DE CORTES | CUT FORMULAS**

Perfiles de marco   Frame Profiles					
Sección   Section	Descripción   Description	Referencia   Cod.	Corte   Cut	Medida   Med.	Cantidad   Qty.
	Marco 77 mm <i>Frame 77 mm</i>	79100		L	2
				H	2
	Hoja 77 mm <i>Sash 77 mm</i>	79101		$[L - 80,2 - (N + 1) \times 12 - 51] / N$	$(N-1) \times 2$
				$[[L - 80,2 - (N - 1) \times 12 - 51] / N] + 51$	2
				H - 90,2	N x 2
	Complemento cerradura 77 mm <i>77 mm lock complement profile</i>	79102		H - 76,2	2
	Batiente <i>Profile support</i>	79103		L - 38,2	2
				H - 59,2	1
				H - 59,2	1
				H - 90	1
	Suplemento 14 mm <i>Supplement profile 14 mm</i>	79104		$[L - 80,2 - (N + 1) \times 12 - 51] / N$	$(N-1) \times 2$
				$[[L - 80,2 - (N - 1) \times 12 - 51] / N] + 51$	2
	Complemento para felpudo <i>Profile Complement for felt</i>	79105		L / N (Medida aprox.)	N x 2
	Junquillo recto <i>Straight glazing</i>	(**)		$[L - 92,2 - (N \times 92) - 51] / N$	$(N-1) \times 2$
				$[[L - 92,2 - (N \times 92) - 51] / N] + 51$	2
				H - 210,2	N x 2

(\*\*) Seleccionar junquillos en página de acristamientos

*(\*\*) Select straight glazing on the glazing page*

Vidrios   Glasses			
Medidas   Med.			Cantidad   Qty.
Con marco inferior 79100 <i>With bottom frame 79100</i>	$[L - 306,2 - (N - 2) \times 107 - 51] / N$	H - 185	N - 1
	$[[L - 306,2 - (N - 2) \times 107 - 51] / N] + 51$		1

**Plegable con MARCO INFERIOR 79100, CIERRE CENTRAL**

*Folding with LOWER FRAME 79100, CENTRAL CLOSURE*

Esquemas: 220, 321, 440, 541, 532, 660, 761, 752, 743 y 880

*Scheme: 220, 321, 440, 541, 532, 660, 761, 752, 743 and 880*

Cierre central con 1 perfiles 79102







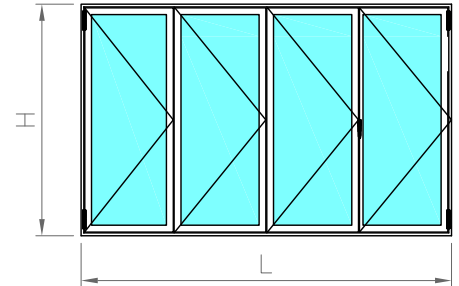















*Central closure with 1 profiles 79102*

N = número de hojas

*N = number of sashes*



**FÓRMULAS DE CORTES | CUT FORMULAS**

Perfiles de marco   Frame Profiles					
Sección   Section	Descripción   Description	Referencia   Cod.	Corte   Cut	Medida   Med.	Cantidad   Qty.
	Marco 77 mm <i>Frame 77 mm</i>	79100		L	2
				H	2
	Hoja 77 mm <i>Sash 77 mm</i>	79101		$[L - 66,2 - (N + 1) \times 12 - 51] / N$	$(N-1) \times 2$
				$[[L - 66,2 - (N - 1) \times 12 - 51] / N] + 51$	2
				H - 90,2	N x 2
	Complemento cerradura 77 mm <i>77 mm lock complement profile</i>	79102		H - 76,2	1
	Batiente <i>Profile support</i>	79103		L - 38,2	1
				H - 59,2	1
				H - 59,2	1
				H - 90	1
	Suplemento 14 mm <i>Supplement profile 14 mm</i>	79104		$[L - 66,2 - (N + 1) \times 12 - 51] / N$	$(N-1) \times 2$
				$[[L - 66,2 - (N - 1) \times 12 - 51] / N] + 51$	2
	Complemento para felpudo <i>Profile Complement for felt</i>	79105		L / N (Medida aprox.)	N x 2
	Junquillo recto <i>Straight glazing</i>	(**)		$[L - 78,2 - (N \times 92) - 51] / N$	$(N-1) \times 2$
				$[[L - 78,2 - (N \times 92) - 51] / N] + 51$	2
				H - 210,2	N x 2

(\*\*) Seleccionar junquillos en página de acristamientos

*(\*\*) Select straight glazing on the glazing page*

Vidrios   Glasses			
Medidas   Med.			Cantidad   Qty.
Con marco inferior 79100 <i>With bottom frame 79100</i>	$[L - 292 - (N - 2) \times 107 - 51] / N$	H - 185	N - 1
	$[[L - 292 - (N - 2) \times 107 - 51] / N] + 51$		1

**Plegable con MARCO INFERIOR 79100, CIERRE CENTRAL**

*Folding with LOWER FRAME 79100, CENTRAL CLOSURE*

Esquemas: 220, 321, 440, 541, 532, 660, 761, 752, 743 y 880

*Scheme: 220, 321, 440, 541, 532, 660, 761, 752, 743 and 880*

Cierre central sin perfiles 79102







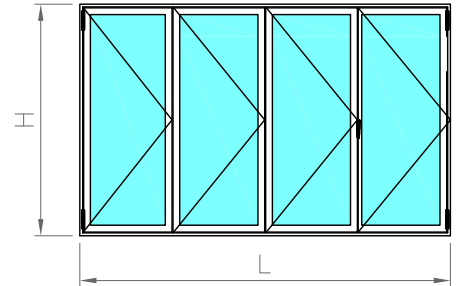













*Central closure without profiles 79102*

N = número de hojas

*N = number of sashes*



**FÓRMULAS DE CORTES | CUT FORMULAS**

Perfiles de marco   Frame Profiles					
Sección   Section	Descripción   Description	Referencia   Cod.	Corte   Cut	Medida   Med.	Cantidad   Qty.
	Marco 77 mm <i>Frame 77 mm</i>	79100		L	2
				H	2
	Hoja 77 mm <i>Sash 77 mm</i>	79101		$[L - 52,2 - (N + 1) \times 12 - 51] / N$	$(N-1) \times 2$
				$[[L - 52,2 - (N - 1) \times 12 - 51] / N] + 51$	2
				H - 90,2	N x 2
	Batiente <i>Profile support</i>	79103		L - 38,2	1
				H - 59,2	1
				H - 59,2	1
				H - 90	1
	Suplemento 14 mm <i>Supplement profile 14 mm</i>	79104		$[L - 52,2 - (N + 1) \times 12 - 51] / N$	$(N-1) \times 2$
				$[[L - 52,2 - (N - 1) \times 12 - 51] / N] + 51$	2
	Complemento para felpudo <i>Profile Complement for felt</i>	79105		L / N (Medida aprox.)	N x 2
	Junquillo recto <i>Straight glazing</i>	(**)		$[L - 64,2 - (N \times 92) - 51] / N$	$(N-1) \times 2$
				$[[L - 64,2 - (N \times 92) - 51] / N] + 51$	2
				H - 210,2	N x 2

(\*\*) Seleccionar junquillos en página de acristalamientos

*(\*\*) Select straight glazing on the glazing page*

Vidrios   Glasses			
Medidas   Med.			Cantidad   Qty.
Con marco inferior 79100 <i>With bottom frame 79100</i>	$[L - 171,2 - (N - 2) \times 107 - 51] / N$	H - 185	N - 1
	$[[L - 171,2 - (N - 2) \times 107 - 51] / N] + 51$		1

## Plegable con MARCO INFERIOR 79100, CIERRE CENTRAL

*Folding with LOWER FRAME 79100, CENTRAL CLOSURE*

Esquemas: 211, 330, 431, 550, 633, 651, 871 y 853

*Scheme: 211, 330, 431, 550, 633, 651, 770, 871 and 853*

Cierre central con 2 perfiles 79102







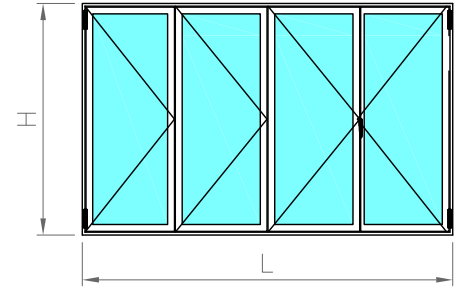











*Central closure with 2 profiles 79102*

N = número de hojas

*N = number of sashes*



## FÓRMULAS DE CORTES | CUT FORMULAS

Perfiles de marco   Frame Profiles					
Sección   Section	Descripción   Description	Referencia   Cod.	Corte   Cut	Medida   Med.	Cantidad   Qty.
	Marco 77 mm <i>Frame 77 mm</i>	79100		L	2
				H	2
	Hoja 77 mm <i>Sash 77 mm</i>	79101		$[L - 80,2 - (N + 1) \times 12] / N$	$N \times 2$
				H - 90,2	$N \times 2$
	Complemento cerradura 77 mm <i>77 mm lock complement profile</i>	79102		H - 76,2	2
	Batiente <i>Profile support</i>	79103		L - 38,2	2
				H - 38,2	2
				H - 90	1
	Suplemento 14 mm <i>Supplement profile 14 mm</i>	79104		$[L - 80,2 - (N + 1) \times 12] / N$	$N \times 2$
	Complemento para felpudo <i>Profile Complement for felt</i>	79105		L / N (Medida aprox.)	$N \times 2$
	Junquillo recto <i>Straight glazing</i>	(**)		$[L - 92,2 - (N \times 92)] / N$	$N \times 2$
				H - 210,2	$N \times 2$

(\*\*) Seleccionar junquillos en página de acristalamientos

*(\*\*) Select straight glazing on the glazing page*

Vidrios   Glasses			
Medidas   Med.			Cantidad   Qty.
Con marco inferior 79100 <i>With bottom frame 79100</i>	$[L - 306,2 - (N - 2) \times 107] / N$	H - 185	N

**Plegable con MARCO INFERIOR 79100, CIERRE CENTRAL**

*Folding with LOWER FRAME 79100, CENTRAL CLOSURE*

Esquemas: 211, 330, 431, 550, 633, 651, 770, 871 y 853

*Scheme: 211, 330, 431, 550, 633, 651, 770, 871 and 853*

Cierre central con 1 perfiles 79102







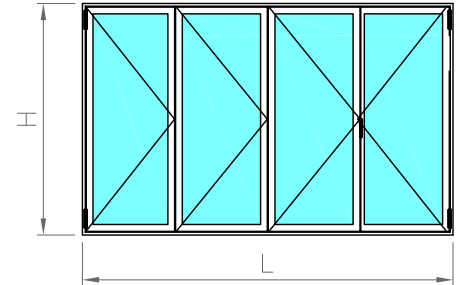











*Central closure with 1 profiles 79102*

N = número de hojas

*N = number of sashes*



**FÓRMULAS DE CORTES | CUT FORMULAS**

Perfiles de marco   Frame Profiles					
Sección   Section	Descripción   Description	Referencia   Cod.	Corte   Cut	Medida   Med.	Cantidad   Qty.
	Marco 77 mm <i>Frame 77 mm</i>	79100		L	2
				H	2
	Hoja 77 mm <i>Sash 77 mm</i>	79101		$[L - 66,2 - (N + 1) \times 12] / N$	N x 2
				H - 90,2	N x 2
	Complemento cerradura 77 mm <i>77 mm lock complement profile</i>	79102		H - 76,2	1
	Batiente <i>Profile support</i>	79103		L - 38,2	2
				H - 38,2	2
				H - 90	1
	Suplemento 14 mm <i>Supplement profile 14 mm</i>	79104		$[L - 66,2 - (N + 1) \times 12] / N$	N x 2
	Complemento para felpudo <i>Profile Complement for felt</i>	79105		L / N (Medida aprox.)	N
	Junquillo recto <i>Straight glazing</i>	(**)		$[L - 78,2 - (N \times 92)] / N$	N x 2
				H - 210,2	N x 2

(\*\*) Seleccionar junquillos en página de acristalamientos

*(\*\*) Select straight glazing on the glazing page*

Vidrios   Glasses			
Medidas   Med.			Cantidad   Qty.
Con marco inferior 79100 <i>With bottom frame 79100</i>	$[L - 292 - (N - 2) \times 107] / N$	H - 185	N



Plegable con MARCO INFERIOR 79100, CIERRE CENTRAL

Folding with LOWER FRAME 79100, CENTRAL CLOSURE

Esquemas: 211, 330, 431, 550, 633, 651, 770, 871 y 853

Scheme: 211, 330, 431, 550, 633, 651, 770, 871 and 853

Cierre central sin perfiles 79102







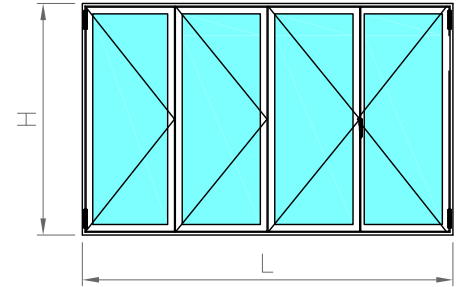









Central closure without profiles 79102

N = número de hojas

N = number of sashes



FÓRMULAS DE CORTES | CUT FORMULAS

Perfiles de marco   Frame Profiles					
Sección   Section	Descripción   Description	Referencia   Cod.	Corte   Cut	Medida   Med.	Cantidad   Qty.
	Marco 77 mm <i>Frame 77 mm</i>	79100		L	2
				H	2
	Hoja 77 mm <i>Sash 77 mm</i>	79101		$[L - 52,2 - (N + 1) \times 12] / N$	N x 2
				H - 90,2	N x 2
	Batiente <i>Profile support</i>	79103		L - 38,2	2
				H - 38,2	2
				H - 90	1
	Suplemento 14 mm <i>Supplement profile 14 mm</i>	79104		$[L - 52,2 - (N + 1) \times 12] / N$	N x 2
	Complemento para felpudo <i>Profile Complement for felt</i>	79105		L / N (Medida aprox.)	N
	Junquillo recto <i>Straight glazing</i>	(**)		$[L - 64,2 - (N \times 92)] / N$	N x 2
				H - 210,2	N x 2

(\*\*) Seleccionar junquillos en página de acristalamientos

(\*\*) Select straight glazing on the glazing page

Vidrios   Glasses			
Medidas   Med.			Cantidad   Qty.
Con marco inferior 79100 <i>With bottom frame 79100</i>	$[L - 171,2 - (N - 2) \times 107] / N$	H - 185	N

**Sección vertical con marco inferior 79106**  
*Vertical section with bottom frame 79106*

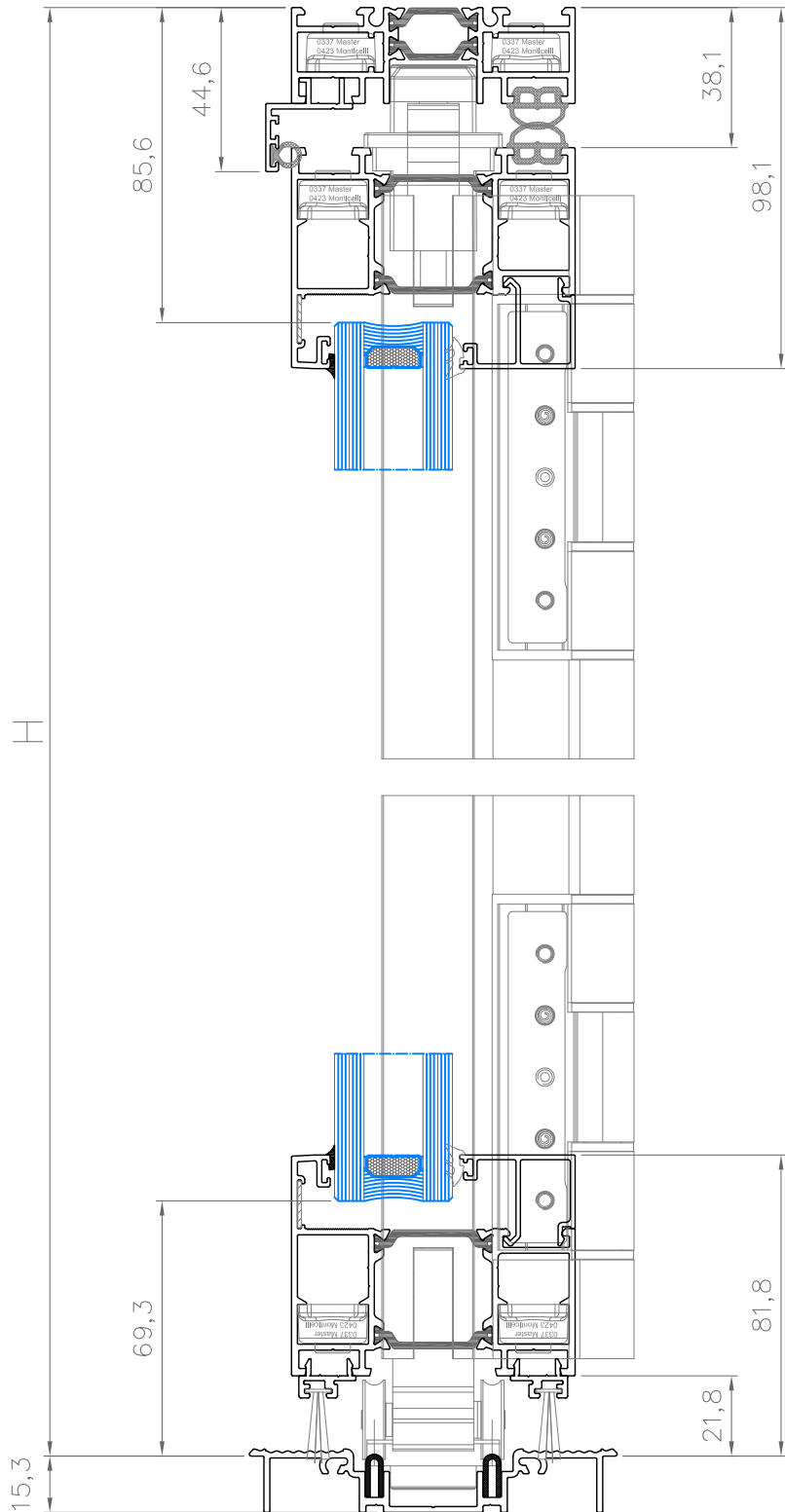

**Solución inferior "H"**  
*Lower solution "H"*

## Plegable con MARCO INFERIOR 79106, CIERRE CENTRAL

Folding with LOWER FRAME 79106, CENTRAL CLOSURE

Esquemas: 422, 642, 844 y 862

Scheme: 422, 642, 844 y 862

Cierre central con 2 perfiles 79102







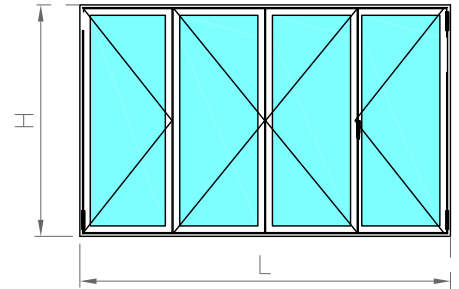

















Central closure with 2 profiles 79102

N = número de hojas

N = number of sashes



## FÓRMULAS DE CORTES | CUT FORMULAS

Perfiles de marco   Frame Profiles					
Sección   Section	Descripción   Description	Referencia   Cod.	Corte   Cut	Medida   Med.	Cantidad   Qty.
	Marco 77 mm Frame 77 mm	79100		L	1
				H - 1,4	1
				H - 1,4	1
	Hoja 77 mm Sash 77 mm	79101		$[L - 80,2 - (N + 1) \times 12 - 102] / N$	(N-2) x 2
				$[[L - 80,2 - (N - 1) \times 12 - 102] / N] + 51$	4
				H - 59,9	N x 2
	Complemento cerradura 77 mm 77 mm lock complement profile	79102		H - 59,9	2
	Batiente Profile support	79103		L - 38,2	1
				H - 20,5	1
				H - 20,5	1
	Complemento para felpudo Profile Complement for felt	79105		L / N (Medida Aprox)	N x 2
	Solera enrasada 100 mm Flush profile 100 mm	79106		L	1
	Tapa 42 mm solera enrasada Cover profile 42 mm flush profile	79107		L	1
	Junquillo recto Straight glazing	(**)		$[L - 90,2 - (N \times 92) - 51] / N$	(N-1) x 2
				$[[L - 92,2 - (N \times 92) - 51] / N] + 51$	2
				H - 179,9	N x 2

Solución inferior "H"  
Lower solution "H"

(\*) Consultar disponibilidad

(\*) Check availability

(\*\*) Seleccionar junquillos en página de acristalamientos

(\*\*) Select straight glazing on the glazing page

Vidrios   Glasses			
Medidas   Med.			Cantidad   Qty.
Con marco inferior 79106 With bottom frame 79106	$[L - 306,2 - (N - 2) \times 107 - 51] / N$	H - 155	N-1
	$[[L - 306,2 - (N - 2) \times 107 - 51] / N] + 51$		1

## Plegable con MARCO INFERIOR 79106, CIERRE LATERAL

Folding with LOWER FRAME 79106, SIDE CLOSURE

Esquemas: 422, 642, 844 y 862

Scheme: 422, 642, 844 y 862

Cierre central con 1 perfil 79102







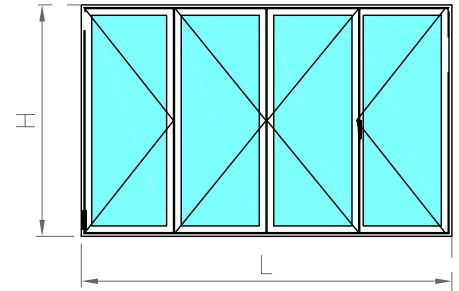















Central closure with 1 profile 79102

N = número de hojas

N = number of sashes



## FÓRMULAS DE CORTES | CUT FORMULAS

Perfiles de marco   Frame Profiles					
Sección   Section	Descripción   Description	Referencia   Cod.	Corte   Cut	Medida   Med.	Cantidad   Qty.
	Marco 77 mm Frame 77 mm	79100		L	1
				H - 1,4	1
				H - 1,4	1
	Hoja 77 mm Sash 77 mm	79101		$[L - 66,2 - (N + 1) \times 12 - 102] / N$	$(N-2) \times 2$
				$[[L - 66,2 - (N - 1) \times 12 - 102] / N] + 51$	4
				H - 59,9	N x 2
	Complemento cerradura 77 mm 77 mm lock complement profile	79102		H - 59,9	1
	Batiante Profile support	79103		L - 38,2	1
				H - 20,5	1
				H - 20,5	1
	Complemento para felpudo Profile Complement for felt	79105		L / N (Medida Aprox)	N x 2
	Solera enrasada 100 mm Flush profile 100 mm	79106		L	1
	(*) Tapa 42 mm solera enrasada Cover profile 42 mm flush profile	79107		L	1
	Junquillo recto Straight glazing	(**)		$[L - 78,2 - (N \times 92) - 51] / N$	$(N-1) \times 2$
				$[[L - 78,2 - (N \times 92) - 51] / N] + 51$	2
				H - 179,9	N x 2

Solución inferior "H"  
Lower solution "H"

(\*) Consultar disponibilidad

(\*) Check availability

(\*\*) Seleccionar junquillos en página de acristalamientos

(\*\*) Select straight glazing on the glazing page

Vidrios   Glasses			
Medidas   Med.			Cantidad   Qty.
Con marco inferior 79106 With bottom frame 79106	$[L - 185,2 - (N - 2) \times 107 - 51] / N$	H - 155	N-1
	$[[L - 185,2 - (N - 2) \times 107 - 51] / N] + 51$		1

## Plegable con MARCO INFERIOR 79106, CIERRE CENTRAL

Folding with LOWER FRAME 79106, CENTRAL CLOSURE

Esquemas: 422, 642, 844 y 862

Scheme: 422, 642, 844 y 862

Cierre central sin perfiles 79102







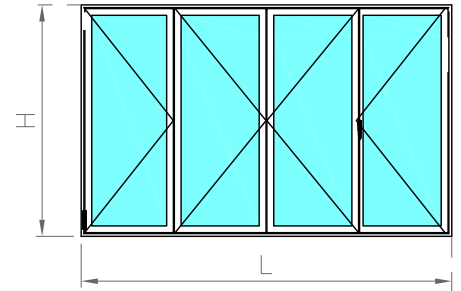















Central closure without profiles 79102

N = número de hojas

N = number of sashes



## FÓRMULAS DE CORTES | CUT FORMULAS

Perfiles de marco   Frame Profiles					
Sección   Section	Descripción   Description	Referencia   Cod.	Corte   Cut	Medida   Med.	Cantidad   Qty.
	Marco 77 mm Frame 77 mm	79100		L	1
				H - 1,4	1
				H - 1,4	1
	Hoja 77 mm Sash 77 mm	79101		$[L - 52,2 - (N + 1) \times 12 - 102] / N$	$(N-2) \times 2$
				$[[L - 52,2 - (N - 1) \times 12 - 102] / N] + 51$	4
				H - 59,9	N x 2
	Batiente Profile support	79103		L - 38,2	1
				H - 20,5	1
				H - 20,5	1
	Complemento para felpudo Profile Complement for felt	79105		L / N (Medida Aprox)	N x 2
	Solera enrasada 100 mm Flush profile 100 mm	79106		L	1
	Tapa 42 mm solera enrasada Cover profile 42 mm flush profile	79107		L	1
	Junquillo recto Straight glazing	(**)		$[L - 64,2 - (N \times 92) - 51] / N$	$(N-1) \times 2$
				$[[L - 64,2 - (N \times 92) - 51] / N] + 51$	2
				H - 179,9	N x 2

Solución inferior "H"  
Lower solution "H"

(\*) Consultar disponibilidad

(\*) Check availability

(\*\*) Seleccionar junquillos en página de acristalamientos

(\*\*) Select straight glazing on the glazing page

Vidrios   Glasses			
Medidas   Med.			Cantidad   Qty.
Con marco inferior 79106 With bottom frame 79106	$[L - 171,2 - (N - 2) \times 107 - 51] / N$	H - 155	N-1
	$[[L - 171,2 - (N - 2) \times 107 - 51] / N] + 51$		1

**Plegable con MARCO INFERIOR 79106, CIERRE CENTRAL**

*Folding with LOWER FRAME 79106, CENTRAL CLOSURE*

Esquemas: 321, 541, 532, 660, 761, 752 y 743

*Scheme: 220, 321, 440, 541, 532, 660, 761, 752 and 743*

Cierre central con 2 perfiles 79102







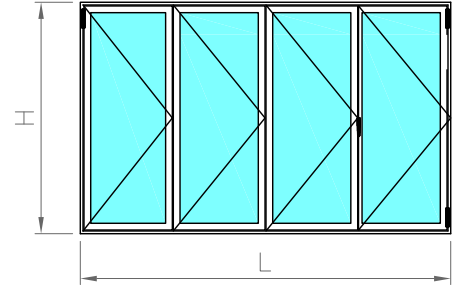

















*Central closure with 2 profiles 79102*

N = número de hojas

*N = number of sashes*



**FÓRMULAS DE CORTES | CUT FORMULAS**

Perfiles de marco   Frame Profiles					
Sección   Section	Descripción   Description	Referencia   Cod.	Corte   Cut	Medida   Med.	Cantidad   Qty.
	Marco 77 mm <i>Frame 77 mm</i>	79100		L	1
				H - 1,4	1
				H - 1,4	1
	Hoja 77 mm <i>Sash 77 mm</i>	79101		$[L - 80,2 - (N + 1) \times 12 - 51] / N$	(N-1) x 2
				$[[L - 80,2 - (N + 1) \times 12 - 51] + 51] / N$	2
				H - 59,9	N x 2
	Complemento cerradura 77 mm <i>77 mm lock complement profile</i>	79102		H - 59,9	2
	Batiente <i>Profile support</i>	79103		L - 38,2	1
				H - 20,5	1
				H - 20,5	1
	Complemento para felpudo <i>Profile Complement for felt</i>	79105		L / N (Medida Aprox)	N x 2
	Solera enrasada 100 mm <i>Flush profile 100 mm</i>	79106		L	1
	Tapa 42 mm solera enrasada <i>Cover profile 42 mm flush profile</i>	79107		L	1
	Junquillo recto <i>Straight glazing</i>	(**)		$[L - 90,2 - (N \times 92) - 51] / N$	(N-1) x 2
				$[[L - 92,2 - (N \times 92) - 51] / N] + 51$	2
				H - 179,9	N x 2

Solución inferior "H"  
*Lower solution "H"*

(\*) Consultar disponibilidad

*(\*) Check availability*

(\*\*) Seleccionar junquillos en página de acristamientos

*(\*\*) Select straight glazing on the glazing page*

Vidrios   Glasses			
Medidas   Med.			Cantidad   Qty.
Con marco inferior 79106 <i>With bottom frame 79106</i>	$[L - 306,2 - (N - 2) \times 107 - 51] / N$	H - 155	N-1
	$[[L - 306,2 - (N - 2) \times 107 - 51] / N] + 51$		1

## Plegable con MARCO INFERIOR 79106, CIERRE LATERAL

Folding with LOWER FRAME 79106, SIDE CLOSURE

Esquemas: 220, 321, 440, 541, 532, 660, 761, 752, 743 y 880

Scheme: 220, 321, 440, 541, 532, 660, 761, 752, 743 and 880

Cierre central con 1 perfil 79102







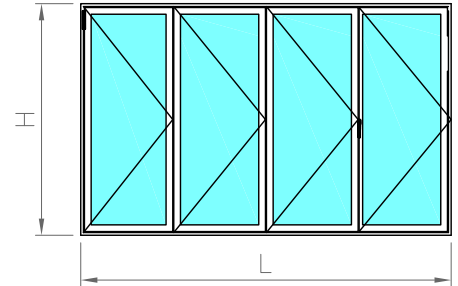

















Central closure with 1 profile 79102

N = número de hojas

N = number of sashes



## FÓRMULAS DE CORTES | CUT FORMULAS

Perfiles de marco   Frame Profiles					
Sección   Section	Descripción   Description	Referencia   Cod.	Corte   Cut	Medida   Med.	Cantidad   Qty.
	Marco 77 mm Frame 77 mm	79100		L	1
				H - 1,4	1
				H - 1,4	1
	Hoja 77 mm Sash 77 mm	79101		$[L - 66,2 - (N + 1) \times 12 - 51] / N$	$(N-1) \times 2$
				$[[L - 66,2 - (N + 1) \times 12 - 51] + 51] / N$	2
				H - 59,9	N x 2
	Complemento cerradura 77 mm 77 mm lock complement profile	79102		H - 59,9	1
	Batiente Profile support	79103		L - 38,2	1
				H - 20,5	1
				H - 20,5	1
	Complemento para felpudo Profile Complement for felt	79105		L / N (Medida Aprox)	N x 2
	Solera enrasada 100 mm Flush profile 100 mm	79106		L	1
	Tapa 42 mm solera enrasada Cover profile 42 mm flush profile	79107		L	1
	Junquillo recto Straight glazing	(**)		$[L - 78,2 - (N \times 92) - 51] / N$	$(N-1) \times 2$
				$[[L - 78,2 - (N \times 92) - 51] / N] + 51$	2
				H - 179,9	N x 2

Solución inferior "H"  
Lower solution "H"

(\*) Consultar disponibilidad

(\*) Check availability

(\*\*) Seleccionar junquillos en página de acristamientos

(\*\*) Select straight glazing on the glazing page

Vidrios   Glasses			
Medidas   Med.			Cantidad   Qty.
Con marco inferior 79106 With bottom frame 79106	$[L - 185,2 - (N - 2) \times 107 - 51] / N$	H - 155	N-1
	$[[L - 185,2 - (N - 2) \times 107 - 51] / N] + 51$		1

## Plegable con MARCO INFERIOR 79106, CIERRE CENTRAL

Folding with LOWER FRAME 79106, CENTRAL CLOSURE

Esquemas: 220, 321, 440, 541, 532, 660, 761, 752, 743 y 880

Scheme: 220, 321, 440, 541, 532, 660, 761, 752, 743 and 880

Cierre central sin perfiles 79102







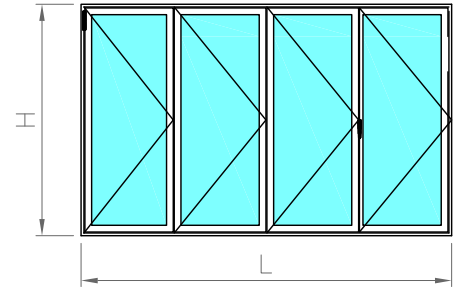















Central closure without profiles 79102

N = número de hojas

N = number of sashes



## FÓRMULAS DE CORTES | CUT FORMULAS

Perfiles de marco   Frame Profiles					
Sección   Section	Descripción   Description	Referencia   Cod.	Corte   Cut	Medida   Med.	Cantidad   Qty.
	Marco 77 mm Frame 77 mm	79100		L	1
				H - 1,4	1
				H - 1,4	1
	Hoja 77 mm Sash 77 mm	79101		$[L - 52,2 - (N + 1) \times 12 - 51] / N$	$(N-1) \times 2$
				$[[L - 52,2 - (N + 1) \times 12 - 51] + 51] / N$	2
				H - 59,9	N x 2
	Battente Profile support	79103		L - 38,2	1
				H - 20,5	1
				H - 20,5	1
	Complemento para felpudo Profile Complement for felt	79105		L / N (Medida Aprox)	N x 2
	Solera enrasada 100 mm Flush profile 100 mm	79106		L	1
	(*) Tapa 42 mm solera enrasada Cover profile 42 mm flush profile	79107		L	1
	Junquillo recto Straight glazing	(**)		$[L - 64,2 - (N \times 92) - 51] / N$	$(N-1) \times 2$
				$[[L - 64,2 - (N \times 92) - 51] / N] + 51$	2
				H - 179,9	N x 2

Solución inferior "H"  
Lower solution "H"

(\*) Consultar disponibilidad

(\*) Check availability

(\*\*) Seleccionar junquillos en página de acristalamientos

(\*\*) Select straight glazing on the glazing page

Vidrios   Glasses			
Medidas   Med.			Cantidad   Qty.
Con marco inferior 79106 With bottom frame 79106	$[L - 171,2 - (N - 2) \times 107 - 51] / N$	H - 155	N-1
	$[[L - 171,2 - (N - 2) \times 107 - 51] / N] + 51$		1



## Plegable con MARCO INFERIOR 79106, CIERRE CENTRAL

*Folding with LOWER FRAME 79106, CENTRAL CLOSURE*

Esquemas: 211, 431, 633, 651, 871 y 853

*Scheme: 211, 431, 633, 651, 871 and 853*

Cierre central con 2 perfiles 79102







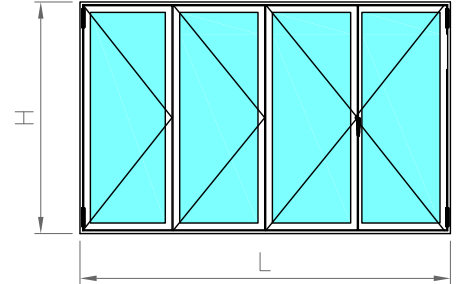















*Central closure with 2 profiles 79102*

N = número de hojas

*N = number of sashes*



## FÓRMULAS DE CORTES | CUT FORMULAS

Perfiles de marco   Frame Profiles					
Sección   Section	Descripción   Description	Referencia   Cod.	Corte   Cut	Medida   Med.	Cantidad   Qty.
	Marco 77 mm <i>Frame 77 mm</i>	79100		L	1
				H - 1,4	1
				H - 1,4	1
	Hoja 77 mm <i>Sash 77 mm</i>	79101		$[L - 80,2 - (N + 1) \times 12] / N$	N x 2
				H - 59,9	N x 2
	Complemento cerradura 77 mm <i>77 mm lock complement profile</i>	79102		H - 59,9	2
	Batiente <i>Profile support</i>	79103		L - 38,2	1
				H - 20,5	1
				H - 20,5	1
				H - 65	1
	Complemento para felpudo <i>Profile Complement for felt</i>	79105		L / N (Medida Aprox)	N x 2
	Solera enrasada 100 mm <i>Flush profile 100 mm</i>	79106		L	1
	Tapa 42 mm solera enrasada <i>Cover profile 42 mm flush profile</i>	79107		L	1
	Junquillo recto <i>Straight glazing</i>	(**)		$[L - 92,2 - (N \times 92)] / N$	N x 2
				H - 179,9	N x 2

Solución inferior "H"  
Lower solution "H"

(\*) Consultar disponibilidad

*(\*) Check availability*

(\*\*) Seleccionar junquillos en página de acristalamientos

*(\*\*) Select straight glazing on the glazing page*

Vidrios   Glasses			
Medidas   Med.			Cantidad   Qty.
Con marco inferior 79106 <i>With bottom frame 79106</i>	$[L - 306,2 - (N - 2) \times 107] / N$	H - 155	N

## Plegable con MARCO INFERIOR 79106, CIERRE LATERAL

*Folding with LOWER FRAME 79106, SIDE CLOSURE*

Esquemas: 211, 330, 431, 550, 633, 651, 770, 871 y 853

*Scheme: 211, 330, 431, 550, 633, 651, 770, 871 and 853*

Cierre central con 1 perfil 79102







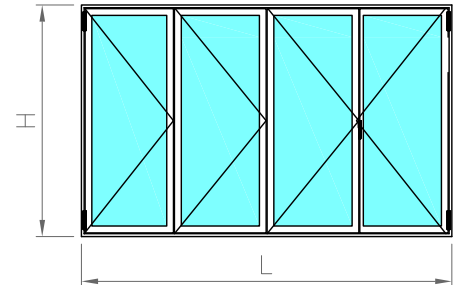















*Central closure with 1 profile 79102*

N = número de hojas

*N = number of sashes*



## FÓRMULAS DE CORTES | CUT FORMULAS

Perfiles de marco   Frame Profiles					
Sección   Section	Descripción   Description	Referencia   Cod.	Corte   Cut	Medida   Med.	Cantidad   Qty.
	Marco 77 mm <i>Frame 77 mm</i>	79100		L	1
				H - 1,4	1
				H - 1,4	1
	Hoja 77 mm <i>Sash 77 mm</i>	79101		$[L - 66,2 - (N + 1) \times 12] / N$	N x 2
				H - 59,9	N x 2
	Complemento cerradura 77 mm <i>77 mm lock complement profile</i>	79102		H - 59,9	1
	Batiente <i>Profile support</i>	79103		L - 38,2	1
				H - 20,5	1
				H - 20,5	1
				H - 65	1
	Complemento para felpudo <i>Profile Complement for felt</i>	79105		L / N (Medida Aprox)	N x 2
	Solera enrasada 100 mm <i>Flush profile 100 mm</i>	79106		L	1
	Tapa 42 mm solera enrasada <i>Cover profile 42 mm flush profile</i>	79107		L	1
	Junquillo recto <i>Straight glazing</i>	(**)		$[L - 78,2 - (N \times 92)] / N$	N x 2
				H - 179,9	N x 2

Solución inferior "H"  
Lower solution "H"

(\*) Consultar disponibilidad

*(\*) Check availability*

(\*\*) Seleccionar junquillos en página de acristalamientos

*(\*\*) Select straight glazing on the glazing page*

Vidrios   Glasses			
Medidas   Med.			Cantidad   Qty.
Con marco inferior 79106 <i>With bottom frame 79106</i>	$[L - 185,2 - (N - 1) \times 107] / N$	H - 155	N

## Plegable con MARCO INFERIOR 79106, CIERRE CENTRAL

*Folding with LOWER FRAME 79106, CENTRAL CLOSURE*

Esquemas: 211, 330, 431, 550, 633, 651, 770, 871 y 853

*Scheme: 211, 330, 431, 550, 633, 651, 770, 871 and 853*

Cierre central sin perfiles 79102







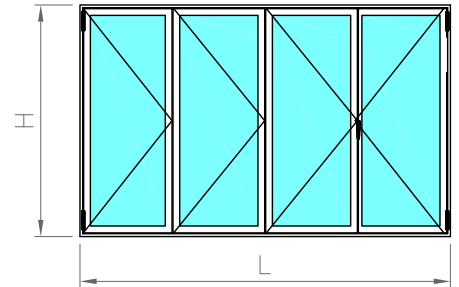













*Central closure without profiles 79102*

N = número de hojas

*N = number of sashes*



## FÓRMULAS DE CORTES | CUT FORMULAS

Perfiles de marco   Frame Profiles					
Sección   Section	Descripción   Description	Referencia   Cod.	Corte   Cut	Medida   Med.	Cantidad   Qty.
	Marco 77 mm <i>Frame 77 mm</i>	79100		L	1
				H - 1,4	1
				H - 1,4	1
	Hoja 77 mm <i>Sash 77 mm</i>	79101		$[L - 52,2 - (N + 1) \times 12] / N$	N x 2
				H - 59,9	N x 2
	Batiente <i>Profile support</i>	79103		L - 38,2	1
				H - 20,5	1
				H - 20,5	1
				H - 65	1
	Complemento para felpudo <i>Profile Complement for felt</i>	79105		L / N (Medida Aprox)	N x 2
	Solera enrasada 100 mm <i>Flush profile 100 mm</i>	79106		L	1
	Tapa 42 mm solera enrasada <i>Cover profile 42 mm flush profile</i>	79107		L	1
	Junquillo recto <i>Straight glazing</i>	(**)		$[L - 64,2 - (N \times 92)] / N$	N x 2
				H - 179,9	N x 2

Solución inferior "H"  
*Lower solution "H"*

(\*) Consultar disponibilidad

*(\*) Check availability*

(\*\*) Seleccionar junquillos en página de acristamientos

*(\*\*) Select straight glazing on the glazing page*

Vidrios   Glasses			
Medidas   Med.			Cantidad   Qty.
Con marco inferior 79106 <i>With bottom frame 79106</i>	$[L - 171,2 - (N - 1) \times 107] / N$	H - 155	N

Qsystems®



**qsline.es**

QS-XL is a patented and design system by QS Line